

# Section 8

Corbin-Gentry Seats .....	2-18
Fender Struts .....	30, 33, 35, 38-40
Fender Trim .....	40-46
FLH, FLT Seats .....	7-8
Fenders	
Front .....	25-29
Rear .....	24, 30-38
Luggage Racks .....	47-50
Saddlemen Seats .....	11
Sissy Bars .....	20-23
Sissy Bar Pads .....	21
Solo Seats .....	3, 5, 7-18
Spring and Brackets .....	12, 16-19

# Corbin-Gentry



Corbin-Gentry's original idea of the ultimate in two-up, long distance riding comfort.



## Freedom Blaster Seat

A well designed seat with 11 inch self support back and unique stitch pattern.

6159 1985-86

## Red Flame Gunfighter Saddles XL 1982-03

Corbin-Gentry original features a hand sewn inlay of red flames on rear pad area with front driver area in matching flame stitching. All models listed constructed on a steel base plate with high density molded form cushion.

96119

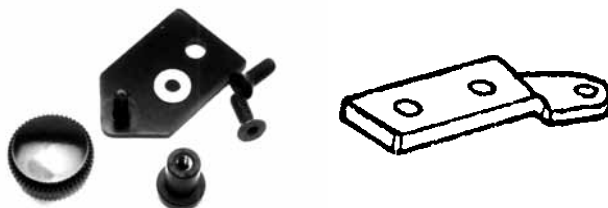

## Knob & Bracket Kit

Attaches rear of seat on FX-FL & FXST models. Allows removal of seat without going under fender with wrench.

1996 Kit

27111 Chrome bracket XL 883 1987-on



## Gunfighter Saddles

Original one up rider design, for low looks and fast curves, by Corbin-Gentry, features fully comfort firm molded foam covered with breathable naugahyde to give years of service. Silver-chrome trim accents driver and tail area.

PCP	Model	Years
96125	FXR-FXRS	1982-94
96128	Sportster	1979-03
96129	Rigid, FXST	1984-99
96215	FXST	1984-05



## Long Haul Saddle for 1996-05 FXD-FXDWG

96487

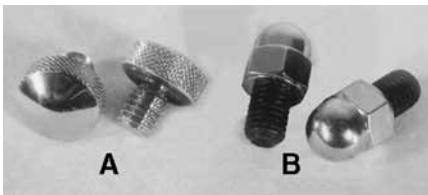

## FXST-FLST Seat Tab Screw Sets 1984-99

Screws have a 1/2 x 13 thread and fit into frame in front of the strut mount. O-ring included.

17260 (A) Knurled

17261 (B) Acorn



## Seat Mounting Brackets

PCP	Application
73538	Zinc nose seat mount tab FXR 1979-on (52107-86)
73539	Chrome rear seat mount tab FX 1979-on (51651-79)
73542	Black rear seat tab assembly 2000-on (52467-00)
73543	Chrome rear seat tab 1982-on (1/4 x 20)
73544	Chrome rear seat tab 1982-on (1/4 x 28)
73540	Chrome rear seat tab FXE-FXWG (51652-83)

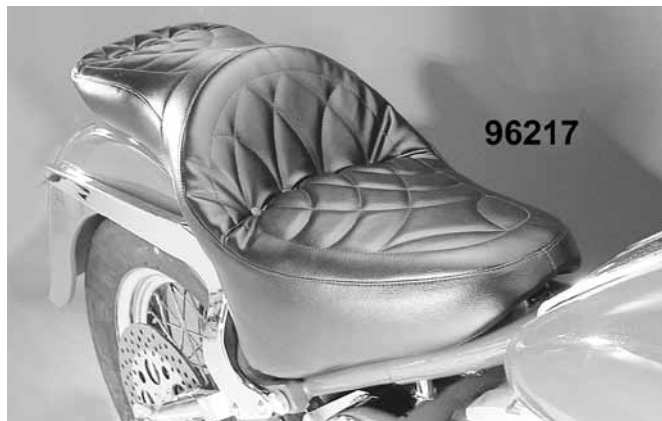

## Victory Double Bucket Touring Saddles

Features extra thick foam padding for plush comfort. Victory saddle seats fit 1984-on FXST-FLST models and all rigid frames. FXST-FLST models require re-use of existing rear tab or separate purchase of a new tab. Rigid frames require separate purchase of front mount.

1984-on	Style	Pattern
96216	Plush	Button
96217	MKIII	Stitch
96218	Long Haul	Spots
96219	Long Haul	Without spots

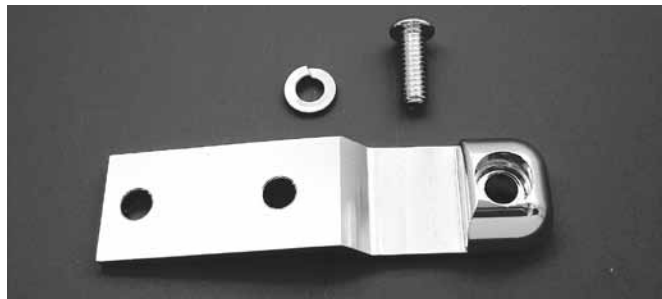

## Chrome Billet Rear Seat Tab

Features contoured rear shape and includes screw. Kits sit where rear tab is fastened by two screws.

73708



## Victory Design Originals by Corbin-Gentry

Fits 1984-05 FX-FLST and Rigid

1984-05	Description
96209	Original pillow
96210	Original pillow, leather
96211	Original pillow, leather, 2" wider
96212	Original pillow 2" wider
96213	Classic pillow



## Corbin-Gentry, Inc. *Soft Tops*

Vinyl	Models	Years
6244	XLX-XLH	1979-03

## Black Button Set

Set of six with clips, for repairing or installing on custom seats.

1999



## Corbin-Gentry Pinnacle Leather Solo Seat

Features a full, genuine leather cover and direct to frame mounting. Fits 1984-05 FXST.

96038

# Corbin-Gentry

**Victory Series Saddles fit 1984-05 FXST-FLST models and all rigid frames. FXST-FLST models require re-use of existing rear tab.**

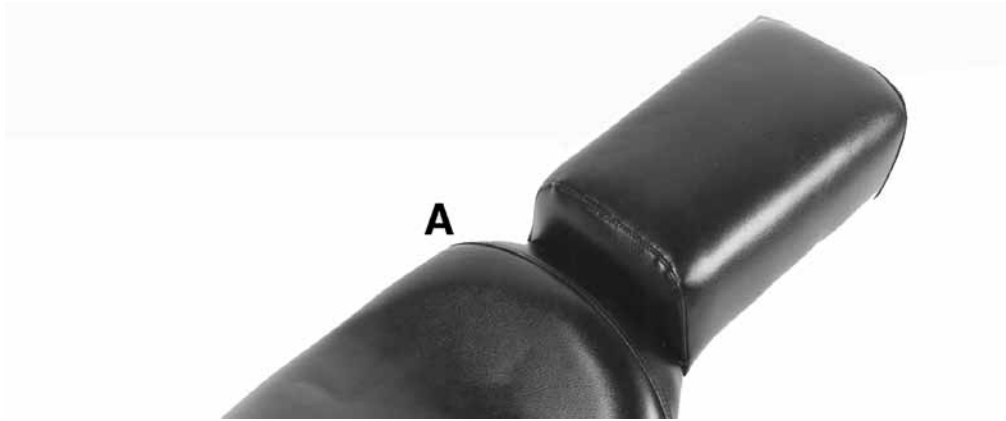

## Victory Smoothie Saddles for Softails

Feature 2 piece design on a single steel base plate. Victory saddle seats fit 1984-05 FXST-FLST models and all rigid frames. FXST-FLST models require re-use of existing rear tab or separate purchase of a new tab. Rigid frames require separate purchase of front mount.

1984-05	1984-99	Description
96193		(A) Original style
96194		(A) Leather, original style
96195	96182	(C) Classic style with concho and chrome spots
96196	96183	(C) Classic style with concho and black spots
96197	96184	(D) Classic style with fringe and chrome spots
73540		Rear tab 1984-99 (51652-83)
73542		Rear tab 2000-on (52467-00)



## Victory Flatlander Saddles for Softails

Feature low, frame hugging design. Fits 1984-05 FXST-FLST models and all Rigid frames. FXST-FLST models require re-use of existing rear tab or one can be ordered separately. Rigid frames require purchase of front mount.

1984-05	1984-99	Description
96202		(A) Original style 1984-05
	96177	(A) As above 1995-99
	96179	(C) Buttoned
73540		Rear tab 1984-99 (51652-83)
73542		Rear tab 2000-on (52467-00)



## Chrome Seat Mount Bolts FXR, Road King

Secure rear of solo seat to hold front of passenger pad firmly in place. Allows for easy passenger pad removal.

PCP	Application (pair)
17262	5/16 x 24 FLHR 1994, FXR 1982-89
17263	5/16 x 18 FLHF 1995-on

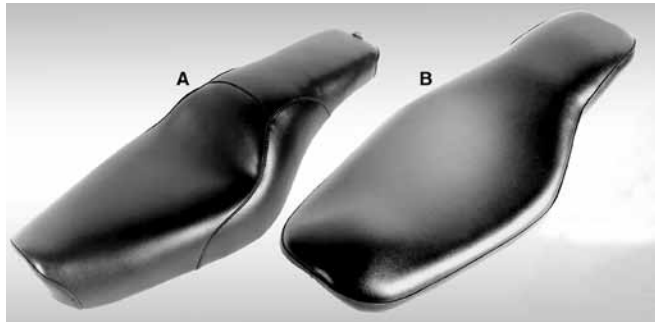
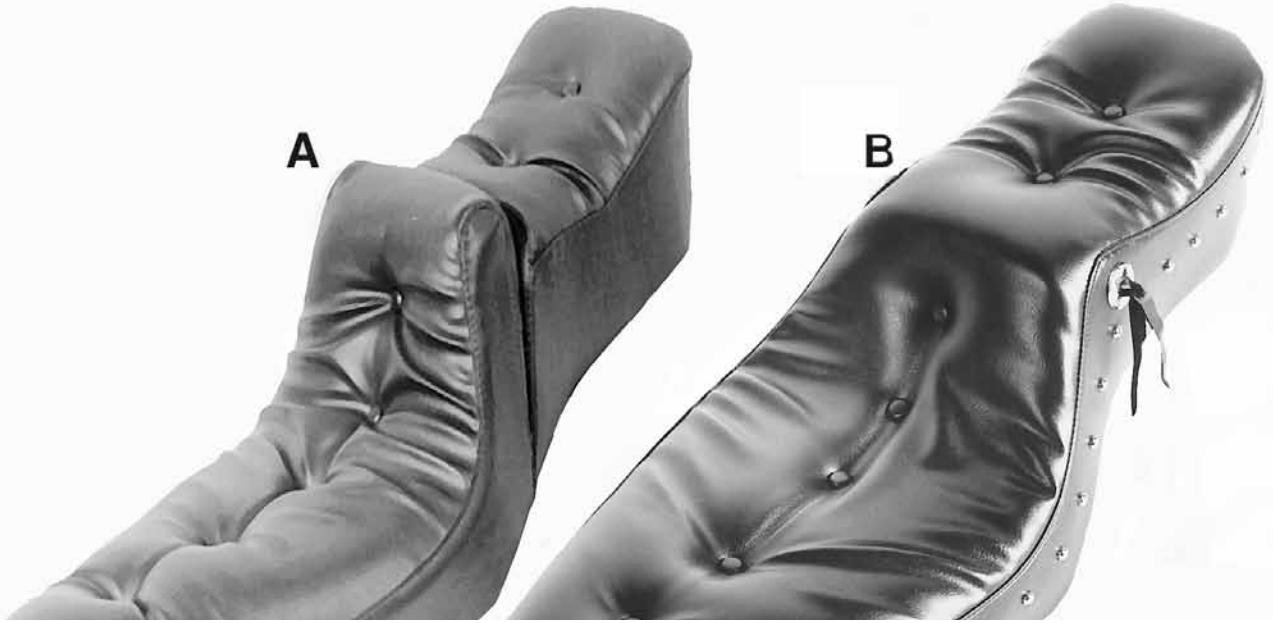

## Invictor Series Seats Sportster 1979-03

PCP	Description
96137	(A) Leather pillow
96134	(A) Leather pillow w/short nose for Bob tank
96135	(A) Pillow w/short nose for Bob tank
6244	(A) Pillow
96138	(B) Classic pillow
96139	(C) MKI

## Invictor Series For XL 1979-03

- 96140 (A) Original
- 96141 (B) Cobra



## Victory Plush Top Saddle

The 11" short back, deluxe pillow set features dual saddle molded foam construction on a single steel base plate. This is the latest in factory styling! Available for all models listed.

PCP	Models	Years
6171	FXST-Rigid frame	1984-99
6174	XL-XLH	1982-03
6176	FX-FXE (Evolution)	1985

FX-FXE (Evolution) 1985-on seats will not fit with seat rail in stock position.

## Wyatt Solo Saddle for FXDWG

PCP	Application
96222	1996-05
96223	2006-on



## Colony FXST Seat Bracket Mounting Bolts 9915

# Corbin-Gentry

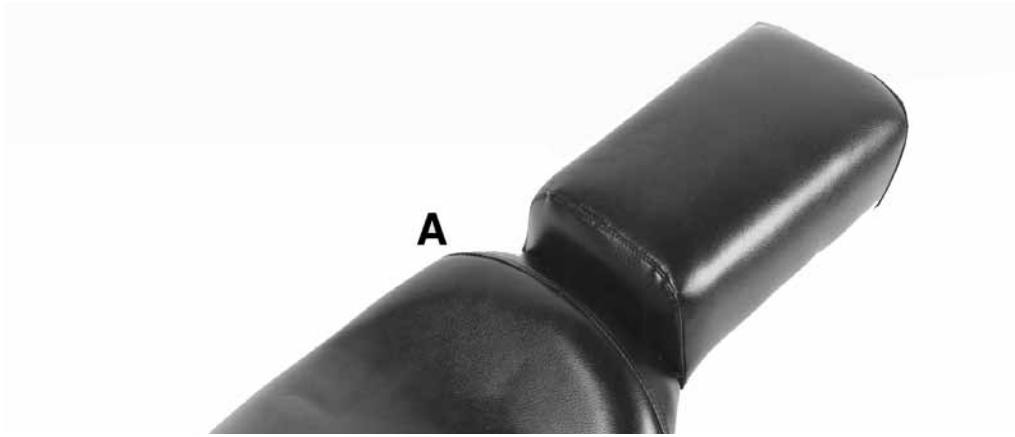

## Invictor Smoothie Saddles Sportster 1979-03

Features solo seat and pad on a single steel baseplate.

- | PCP   | Description                        |
|-------|------------------------------------|
| 96143 | (A) Original style                 |
| 96144 | (A) Leather original style         |
| 96146 | (C) Classic style with black spots |
| 96147 | (D) Classic style with fringe      |



**Classic Fringe Smoothie**



**Classic with black spots**



## Chrome Billet Rear Seat Tab

Features contoured rear shape and includes screw. Kits sit where rear tab is fastened by two screws.

73708



**96134**



**96136**

## Corbin-Gentry Seats for Bobbed Tank Conversions

Seats have a shorter nose to fit XL 1979-03 with larger, Bobbed style tanks. Available in leather or naugahyde. Can also be used on XL 1996-03 with a large 3.3 gallon tank.

- |       |                      |
|-------|----------------------|
| 96134 | Leather pillow       |
| 96135 | Pillow               |
| 96136 | Pillow with 11" back |

# Corbin-Gentry



## Dragon II

Solo is designed for rigid or FXST frames. Full contour steel base, can be run as solo or with a rear pad from our selections. Corbin-Gentry original. Measures 13"W by 17"L.  
**6514**



## XL Voyager Seats 1979-06

Features full comfort design for the longest ride. Seat not as shown, chrome spots not included.

PCP	Year
<b>96225</b>	1979-03 w/o spots
<b>96226</b>	2004-06 w/o spots



## Tour-Pak Backrest Pad

Wrap around pillow style passenger pad with backrest replaces stock style on Touring models. Can also be fitted to earlier FL models with King Tour-Pak.

**96601** Backrest 1997-on with King Tour Pak (52201-97A)



## Chopper Solo Seats

Smaller version in black or white vinyl. Includes nose bracket, accepts seat springs. 9 inches wide, 12-1/2 inches long.

**6637** Black

**96200** White

## Pillion Pad

Black vinyl, measures 4-1/4 inches wide by 8-1/2 inches long.

**6638** Black

**96201** White



## FXST Solo Seat

Fits 1986-99 FXST models.

**59851**



**96500**



**96501**

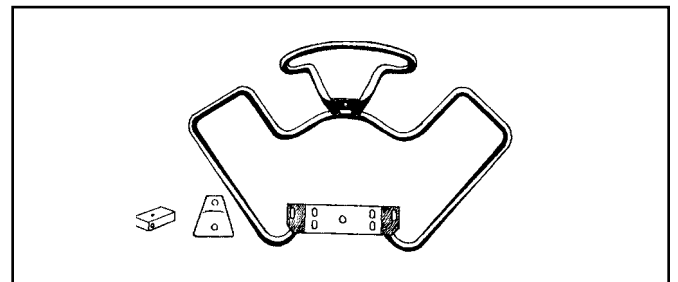

## Passenger Pads

Fit stock seat rails on 1977-89 FLH, FLT, FLHT. Available in pillow style naugahyde to match factory style seats, or our custom stitch. Includes clamp, 13" tall. Passenger pads will fit seat rail shown.

**96500** Custom stitch

**96501** Pillow

**51901** Hand rail fits only FLH 1977-84 (91582-79)

# Corbin-Gentry



96053



96053



96054



96054

## Frame Mount Solo Seats 1996-on

Available in custom stitch or puffy top design for 1983-95 models. Corbin-Gentry designed on reinforced fiberglass base plate. Matching back pad available separately.

PCP	Model
96053	FLT
96054	FLHR



FLT Frame Mounted Solo Seats 1996-06  
96186

# FLH, FLT Saddles



96160



96161



96187

## FLT Saddles 1983-95

Available in custom stitch or puffy top design for 1983-95 models. Corbin-Gentry designed on reinforced fiberglass base plate. Matching back pad available separately.

96160	Puffy Top 1983-95
96161	Diamond Stitch 1983-95
96187	Bucket 1996-07

## Chrome Dash Panel Extension

Fits FLHR 1989-05 with shorter seat.  
45845





96003

### Regal Plush

This seat features a plush finish on a single base plate  
**96003** XL 82-03



96415

### “Monterey” Custom Solo Fringe Series

The frame mounted Monterey series is uniquely designed to offer the ultimate in touring comfort for both rider and passenger. A Le Pera original, this solo is cleverly designed so you can easily change from one pillion pad to another satisfying your choice of styling and passenger needs. All of this can be accomplished with no drilling or alterations to your bike. These solo's are offered in premium naughyde covering with leather fringes. All Monterey series solos and pillions have a carpeted 16-guage powder coated base plate and a high-density molded foam foundation.

<b>Plush</b>	<b>Fits</b>
<b>96415</b>	FXST 1984-99



### VT Rigid Seat Kit

Includes 3" springs and solo seat.  
**96075**



### Velo Racer

Features thin profile with leather construction on stock formed steel baseplate. Edge is original cobbler style with ground and sanded edge. Seat measures 13"W x 16"L with 6-5/8" c/c on rear bolt holes.

<b>96051</b>	Black
<b>96052</b>	Brown



6678

### Pleated 'Signature' Solo Seat

Solo seat features carpeted metal baseplates and a premium-quality black naughyde covering over the dense molded foam cushions. The solo seat, bolts to the stock seats mounts.

Solo seat (measures 20-1/2" L x 13" W).

<b>Seat</b>	<b>Fits</b>
<b>6678</b>	FXST 1984-93

# Solo Seats



**Solo Seat and Mount Kit for 1984-99 FXST**  
Includes leather Police solo seat.  
**96188**



## Velo Racer

Features thin profile with leather construction on stock formed steel baseplate. Edge is original cobbler style with ground and sanded edge. Seat measures 13"W x 16"L with 6-5/8" c/c on rear bolt holes.

- 96402** Black
- 96401** Brown



## Solo Seat

Features naugahyde construction with 6" genuine leather fringe or concho style skirt. Custom solo style accepts 3" or 5" springs. Seat measures 12"L by 9"W and can be mounted with or without seat T's. Matching pad features nickel spots and measures 14"L by 13.5" wide

- | PCP          | Style  |
|--------------|--------|
| <b>96055</b> | Fringe |
| <b>96056</b> | Sonora |
| <b>96903</b> | Pad    |



## Solo Seat Mount and 'T'

For use on 1984-99 ST models with split tanks.

- | PCP          | Item  |
|--------------|-------|
| <b>54003</b> | T     |
| <b>73752</b> | Mount |

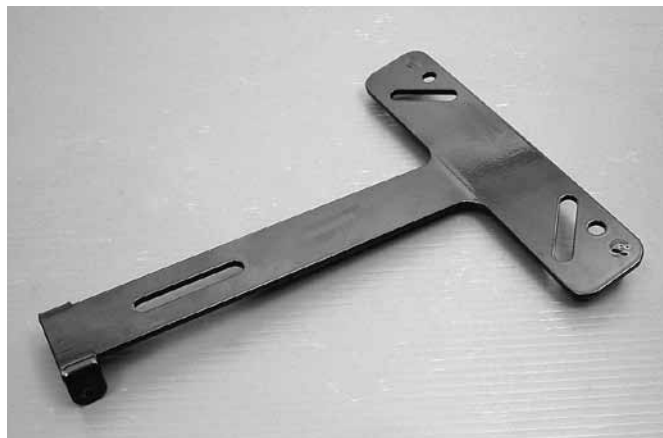

## Universal Seat 'T'

Features slotted mounts to accept most solo seats.  
**54009**



## Preston Smoothie Saddle

One piece solo and pad combination. This new seat features single one piece base plate. Mounts easily to existing fender holes. Fits FX models 1973-on (Except FXR/RS, FXST). Will also fit FL and FLH models 1965-84 and most custom applications.

**Note:** Some early FL applications may require an additional hole to be drilled in fender.

**6123**



**96340**

## Saddlemen Long Rider

The distinctive two texture cover of the Long Rider does two things: First, the looks are unmatched, the velour texture gives a look of luxury. Second, the velour provides uncompromising comfort, cool in the summer, warm when it's cold. The weather proof velour is durable and does not absorb water.

**96340** Softail 1984-99 (inc. FXST, FLST & Fat Boy)

**96342** Dynaglide



**96362**

## Saddlemen Drifter

The highly comfortable Drifter perfectly follows the lines of your bike and has the spirit to separate you from the crowd. The rear portion also has enough cushion for a passenger.

**Drifter Dynaglide 1991-on**

**96362** Black



## Saddlemen Two-Up Saddle

Classic, clean looks separate this comfortable two up saddle from all the others. It's beautifully stitched with a functional pattern that enhances softness and comfort.

**96352** Dynaglide 1991-on



**96400**

## Bates Style Tuck and Roll Solo Kit

Genuine leather solo measures 13"W x 16"L with mount holes 6-5/8" c/c.

**96400**



**96220**

## Voyager Series Seats for FXST 1984-05

Features a full comfort design for long rides.

**PCP Design**

**96220** With spots

**96221** Without spots

# Solo Seat



## XL Leather Solo Seat Kits

Kit includes K model seat, chrome 2" springs and mount hardware.

PCP	Years
96043	1982-03
96044	2004-on



## Metro Solo Seats

Genuine black leather seats on a stock formed steel ribbed baseplate with a rolled and sewn edge; and custom styled black leather skirt.

PCP	Skirt Design
96045	Black spots and red rosettes
96046	Police with side spears and rectangles on rear
96047	Chrome spots
96048	Chrome spots with fringe



**Rigid Solo Seat Mount Kit**  
59958



## Solo Hardware Mount Kits

Kits include nose bracket, 2" springs, and rear bracket. To mount larger type police solos the additional purchase of a cross bar is required.

PCP	Application
59512	1982-03
59513	2004-on



## Black Vinyl Solo Seat Set by Corbin-Gentry

Black naugahyde seat features classic 3 button styling and a metal baseplate. Solo seat measures 12" x 12" and has threaded inserts to accept bolts or studs to mount springs and nose bracket. Pad measures 7" x 11" and mounts by 5/16" bolts on the underside. Mount kit is sold separately.

PCP	Item
96039	Seat set
6636	Solo seat only
59508	Pad only



## Bates Style Tuck and Roll Leather Solo Seat

Stylish black leather seat with stock formed steel ribbed baseplate.

96049

# Solo Seat

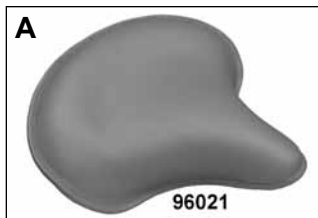
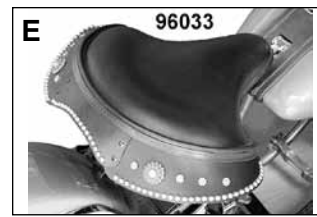

## Replica Leather Solo Seats by Corbin-Gentry

Constructed using genuine drum dyed leather cover with a molded foam pad on an accurate steel formed and ribbed baseplate with riveted brackets as original type. Authentic style seams are accomplished by first riveting a leather strip to the seat pan, then form fitting the leather cover to the saddle and finally sewing the cover to the strip. All seats measure 16" X 16" and fit stock seat T's. Skirts are constructed of Neo Royalite or leather, as noted.

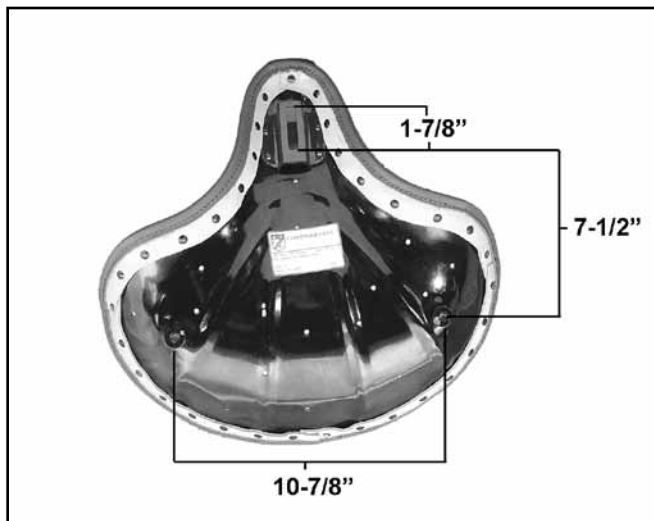

Black	#	Style	Skirt	Details
6633	A	Police	Neo	Spears (52006-47B)
96027	A	Police	Leather	Spears
96025	B	Fringe	Leather	Star-Rosette
96030	B	Fringe	Leather	Star-Rosette
96035	C	Spots	Leather	Star-Rosette
96037	D	1948	Neo	Conchas
96033	E	Early Deluxe	Leather	Conchas
96040	F	1936-40	Leather	Concha-Crystal jewels

White	#	Style	Skirt	Details
96023	A	Police	Leather	Spears
96024	A	Police	No skirt	Spears
96026	B	Fringe	Leather	Blue Rosette
96036	C	Spots	Leather	Blue Rosette
96034	E	Early Deluxe	Leather	Conchas

Brown	#	Style	Skirt	Details
96021	A	Police	Leather	No skirt
96022	F	1936-40	Leather	Concha-Crystal jewels and cobbler seam edge



## Seat Cross Strap

Is required to support Police and K style seats when they are not used with a T-bar, such as on custom seat mount kits. Straps have holes for spring and seat mount.

73720

# Solo Seat

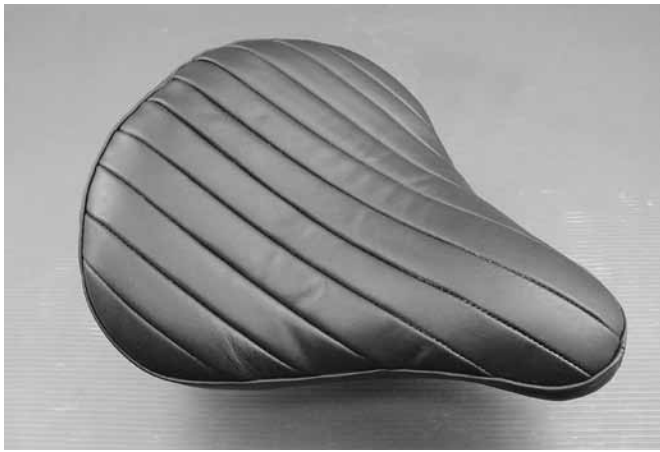

## Chrome Alloy Solo Seat

One piece aluminum forged seat features recesses to fit padded inserts. Seat measures 13 x 13 inches.

**96061** Seat



**96901**



**96902**



**73720**

## Bates Style Tuck and Roll Solo & Pads

Features genuine leather. Solo measures 13"W x 16"L with mount holes at 6-5/8" c/c.

### PCP Description

- 96049** Corbin-Gentry seat
- 96901** Small pad (4-1/4"W x 8-1/2"L)
- 96902** Large pad

## Seat Cross Straps

Will add extra support to Police and K style seats when they are not used with a T bar, such as on custom seat mount kits. Straps have holes for spring and seat mount.

### PCP Description

- 73720** Police 11.5"
- 73721** K-models 10"
- 73722** XLCH models 8"



## 1925 Standard Style Solo-Leather

Leather saddle seat is designed after the thin type "1925" style. Genuine leather on a steel ribbed base plate. Can be fit on Softails 1986-94 using OEM #52225-89, solo seat bracket and spring kit.

**6634** T/L With nylon rivet strip (52004-25)



**96028**

## Corbin-Gentry 1925 Standard Style Solo Seat

This seat features genuine leather with an OEM style steel-ribbed base plate. Seams are finished by riveting a strip to seat pan, and then form fitting the covering to the strip for an authentic look.

**96028** Black (with leather rivet strip)

**96029** Brown (52004-25)

## FXST Solo Seat Kit 2000-on

Includes brackets and hardware to fit Softail models. Lower mount bracket includes integral frame cover. 4" seat springs supplied.

### PCP Item

- 96060** Seat kit
- 27495** Mount kit only



# Solo Seat



## XL Contour Solo Seat

**96050** 1982-03  
**96072** 2004-on



## Velocipede Solo Seats by Corbin Gentry

Features genuine leather cover with cobbler edge sewing.  
 Direct bolt-on to 1986-99 FXST.

### PCP Application

**96207** Black  
**96208** Brown

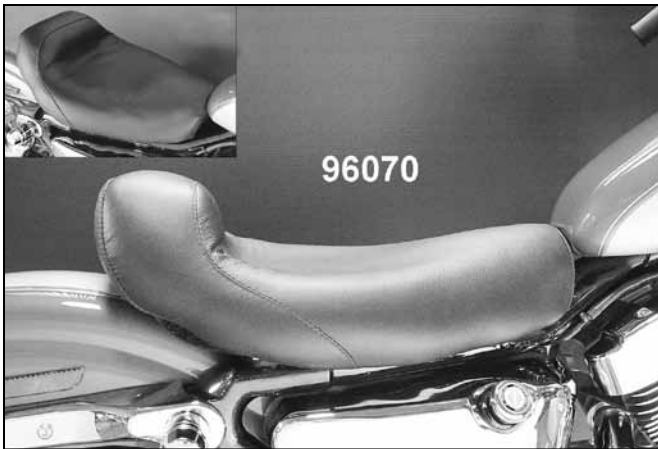

## XL Leather Solo Saddles

Frame mounted to fit stock models.

### PCP Application

**96070** 1979-03  
**96071** 2004-on



## Rigid Seat Kit

Includes 3" springs and solo seat.  
**96075**



## Frame Mount Solo Seat

Fits 1996-on models

### PCP Application

**96053** FLT  
**96054** FLHR

# Seats



96205



96206



96403

## FXST Butt Bucket Saddle

Fits Softail models. Seats include brackets for direct frame mounting.

- 96205 1984-99
- 96206 2000-05
- 96403 2006-on



45259

## Chrome FLST Seat Rail

Fits 1987-99 stock seat and requires removal of stock passenger seat. Rail sold separately.

- 96074 1986-99 Seat
- 45259 1987-99 Rail

## Chrome FLST Seat Rail

Fits 1987-99 stock seats. Requires removal of stock passenger seat.

45259

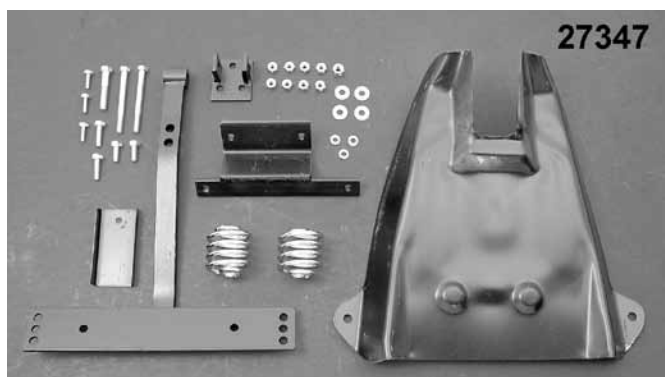

27347

## FLT Solo Seat Mount Kit

Mounting kits include "T" bracket, 2" springs and strut bars for rigid mounting #27347 for 1980-92. #27348 for 1997-on uses a centre spacer for spring. Kits accept standard size police solos and include a black frame cover. Bracket #5537 (sold separately) is required to mount buddy seats on these kits. Seat is not included.

- | PCP   | Application         |
|-------|---------------------|
| 27347 | 1980-92             |
| 27348 | 1997-99             |
| 5537  | Bracket, Buddy seat |



5537



## Seat Rail Mount Kit

Mount kit allows attachment of PCP#6510, to seat T PC#4909 or OEM style (#54001,54002) when fitted with leather police style solo saddles with or without skirts.

- | PCP   | Description               |
|-------|---------------------------|
| 27056 | Mount kit only            |
| 6510  | Seat hand rail (91575-49) |

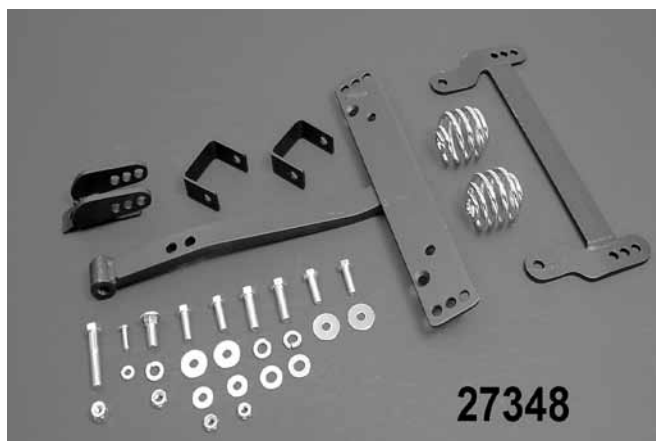

27348

# Solo Seat • Mounting Brackets

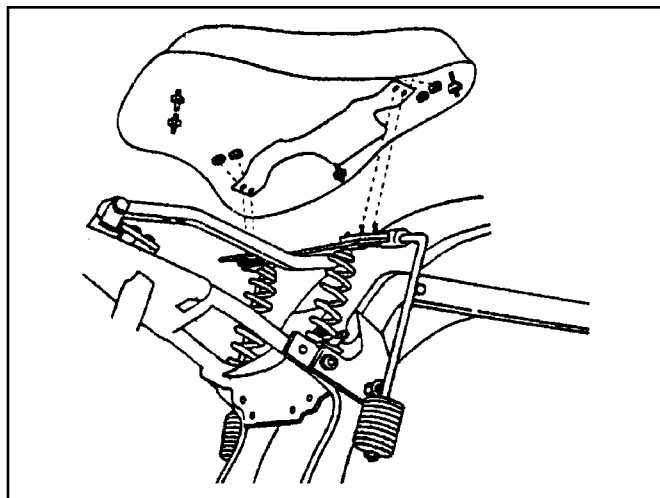

## FXST, FLST Auxillary Spring Set 1986-on

For use with seat "T" kit PCP # 27266 when mounting our buddy or solo seats. Dresses up under the seat area and will provide extra support when springs are engaged.

**27265**

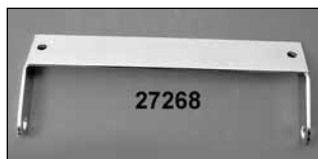
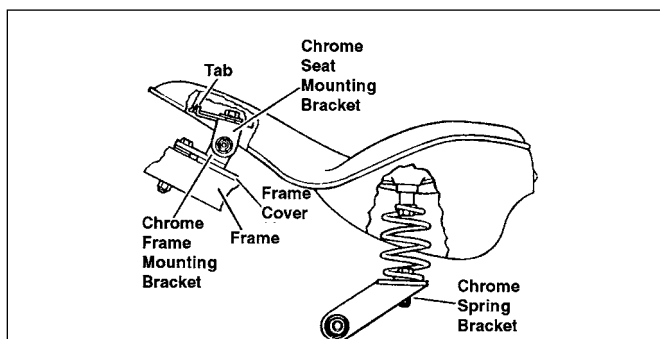

## Chrome Solo Seat Bracket Kit

Use this bracket kit to mount all Police size solo saddles on FXST, FLST 1986-93 models directly to the frame without the use of a "T" bracket. Kit includes all necessary hardware, 4" chrome springs and 2 chrome brackets. Order battery and frame cover separately.

### PCP Description

<b>27267</b>	Bracket kit (52225-89)
<b>27404</b>	Front bracket
<b>27268</b>	Spring cross support only
<b>45413</b>	Black frame cover (52215-89)



## Weld On Stantions

Fits 1" and 1-1/4" cross tubes to support springs.

**73600**

## FLST, FXST Solo Seat Mount Kits 1984-05

Kit includes heavy duty seat "T", pivot mount, 5" chrome springs and all related hardware. Accepts our standard Police Solo size seats. K model styles require use of cross bracket to provide adequate rear mounting distance between seat and fender. For the Dresser look, mount an auxillary spring kit to this seat mounting assembly. A bracket is required to mount nose buddy seat. **Note:** Relay pack may have to be relocated to FXST, FLST 1994-on. Order Chrome frame # 45404 cover separately.

### 1984-99 2000-05

<b>27266</b>	<b>27494</b>	Seat mount kit
<b>5537</b>	-	Auxiliary nose mount bracket (52551-36)
<b>45404</b>	-	Chrome frame cover
<b>45413</b>	<b>45532</b>	Black frame cover



## FL-FXST Frame Cover.

PCP	Fit	Finish
<b>45404</b>	1984-99	Chrome
<b>45413</b>	1984-99	Black (52215-89)
<b>45532</b>	2000-05	Black

# Solo Seat • Mounting Brackets



96067



96068

## Solo Seat Kits FXD-FXDWG

Includes leather solo seat and mount kit for FXD-FXDWG models. Order 1" or 2" springs separately.

Kit	Year
96067	1991-95
96068	1996-05
96069	2006-on



13266



13267



2255



2256



13270



13271



13269

## Chrome Seat Springs

Original, tapered barrel style in 2", 3" or 5" height. The 5" and 7" have a heavy duty 6.5mm wire diameter for stable support. Order various length spring sets as required for height change.

PCP	Size
13266	1"
13267	2"
2255	3"
13268	4"
2256	5"
13270	5"
13271	5"
13269	7"
13272	7"



13268



13272



13265



13262



13263

## Chrome Torsion Type Seat Spring Set

PCP	Size	Type
13262	2"	Regular
13263	2"	Heavy
13264	3"	Heavy
13265	3.5"	Heavy



## FX-FLST Solo Seat Kit 1984-99

Includes mount kit with springs, chrome frame cover and leather solo seat.

96073

# Solo Seat • Mounting Brackets

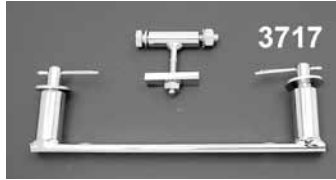
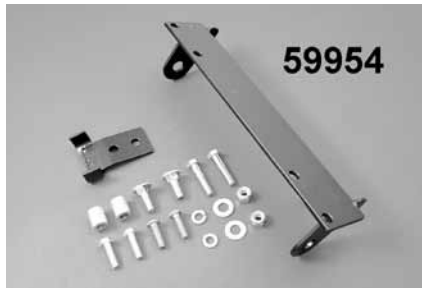

## Solo Seat Mount Kits

Includes nose bracket, chrome springs, and rear brackets to mount small type solos. To mount larger Police seats, purchase cross bar separately.

PCP	Spring	Type	Application
59952	3"	Coil	Rigid
59954	-	Solid	1991-95 Dyna Glide
59955	-	Solid	1996-05 Dyna Glide
59956	2"	Coil	2006-on FXD
59958	2"	Hair pin	Rigid

## FXST Solo Seat Bracket Kit

Use to mount solo seats on 1984-99 FXST models. Note: front 'T' can be used for a universal front seat mount on any frame.

PCP	Item
3717	Complete kit
73719	Front 'T'



## Rigid Frame Seat Mount Brackets

PCP	Item
73718	Kit
2257	Rear mount bar



## Chrome Universal Tilt-Up Nose Bracket

**3703** Fits through backbone of frame, 1-3/4" O.D. For mounting solo seats to most frames.  
**2823** Fits through custom mount spacer (welded to top of frame)



## Solo Seat Mount Bracket

Allows mounting of spring set to underside of solo seats. May be drilled for extra application. Adds support to spring perches.  
**59960**

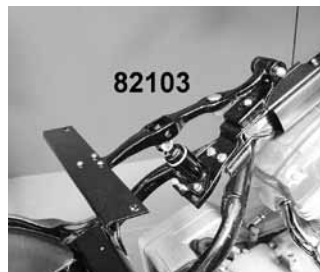

## Seat T and Piston Kit

Fits ST models. Includes black "T", cylinder with internal spring, nose mount and related hardware. Drilling and tapping of frame required.

PCP	Fits	Finish
82089	1984-99	Black
82102	1984-99	Chrome
82103	2000-on	Black
45404	1984-99	Chrome frame cover
45413	1984-99	Black frame cover (52215-89)

# Bolt-On Sissy Bars



## Separate Sissy Bar Side Straps and Backs (NOT FOR DETACHABLES)

Application	Sissy Bar Back Width	Side Straps	Hiboy 16" Back	Lowboy 11" Back (insert style)	Shorty Hand Rail	Mini
FXST/C/S 1984-99	8-3/4"	55830	55843	55847	55851	55854
FXSTS 1988-99						
FXWG 1980-86						
FLSTS 1997-99						
FXST, FXSTS 2000-05	8-3/4"	55861	55843	55847	55851	55854
FLSTF, FXSTB 2000-05						
FLSTF 2007-on	8-3/4"				55851	55854
FLSTN 2005-06	8-3/4"	55861	55843	55847	55851	55854
FLSTC 2000-on	8-3/4"	55862	55843	55847	55851	55854
FLSTS 2000-03						
FLST 2006						
FLSTSC 2005-07						
*2000-02 require extra PCP #24050 Hardware kit						
FLST/C/F/N 1986-99	8-3/4"	55831	55843	55847	55851	55854
FXD 1991-95	6-3/4"	55833	55844	55848	55853	
FXDX 1999, 2002-005	6-3/4"	55834				
FXDXT 2001-05						
FXD/L 1996-01	6-3/4"	55834	55844	55848	55853	
FXD 2002-05	7-1/2"	55834	55858	55859	55852	55860
FXD 2006-on (not FXDWG, FXDF/SE)	8-3/4"	55866	55843		55851	
FXDWG 2006-08	7-3/8"	55865		55850		
FLHR 1994-96	8-3/4"	55835	55843	55847	55851	
FXR 1982-00	6-3/4"	55838	55844	55848	55853	
XL 2004-on	9"	55841	55858	55859	55852	55860
XL 1994-03	6-3/4"	55839	55844	55848	55853	55855
XL 1982-93	8"	55840	55844	55848	55853	55855

Sissy Bar Plate Hardware Kit 2000-02  
24050 53388-03



# Bolt-On Sissy Bars

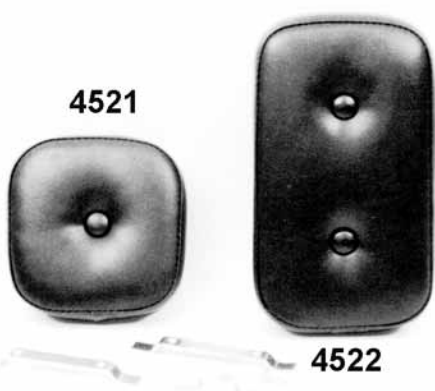

## Button Sissy Bar Pads

These pads will mount to stock sissy bars, single for shorter bars and the 2 button style for taller bars. Mounting brackets are included.

- 4521** Pillow pad 5" tall. Fits our 14" Sissy Bar.
- 4522** Pillow pad 10" tall. Fits our 19" Sissy Bar
- 4523** Smooth original style pad



## Mini Back Rest

Black back rest mounts to short sissy bars using a stainless steel insert with chrome frame mounting system.

**59571** 52513-94



## Chrome Maltese Cross Sissy Bar Inserts

**21733** 4 1/4" tall x 3 5/8" wide, C/C mount holes 1 3/4"



## Solid Sissy Bars

Solid steel, 9/16 square for models listed. 19" model will accept taller pad #4522.

For 12" Bars	For 19" Bars	Width (Inches)	Year Model
<b>1228*</b>	<b>1237*</b>	8-3/16	XLS-XLH 1979-89
<b>6470</b>	-	6-13/16	XLS-XLH 1979-93 (signal notch)
-	<b>55821</b>	6-13/16	XL 1994-03
<b>4955</b>	<b>6465</b>	8-3/4	FXWG-FXST 1980-96
<b>55823</b>	-	8-1/8	FXD 1990-96
<b>4958</b>	-	8-11/16	FLST & FLSTF 1986-96

\*Note: Must use PC#28109 signal extensions on 1990-on

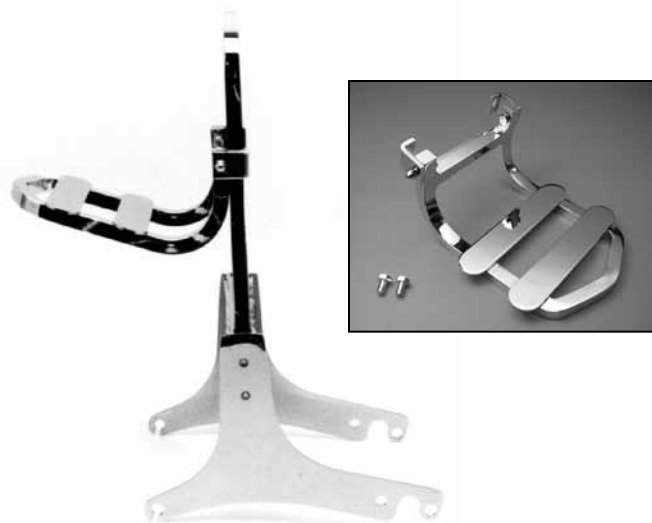

## Sissy Bar Luggage Rack

Made of solid steel and then chrome plated. Fits all 16" tall sissy bars. This unique design allows for easy installation or removal. May require drilling for some applications.

**27159**

# Rigid Sissy Bars

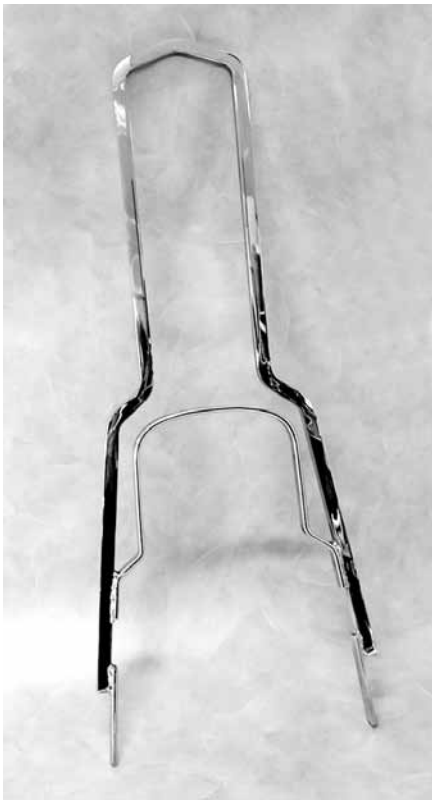

**BT 28" Square Rigid Sissy Bar**  
 10" Inside at mount. Mount holes to be drilled.  
**55806** Chrome



**BT 32" Round Rigid Sissy Bar**  
 11-1/2" Inside at mount.  
**55805** Chrome



**BT 33" Round Stock Sissy Bar**  
 9-7/8" Inside at mount.  
**55809** Chrome



**BT 49" Round Stock Sissy Bar**  
 9-7/8" Inside at mount.  
**55808** Chrome

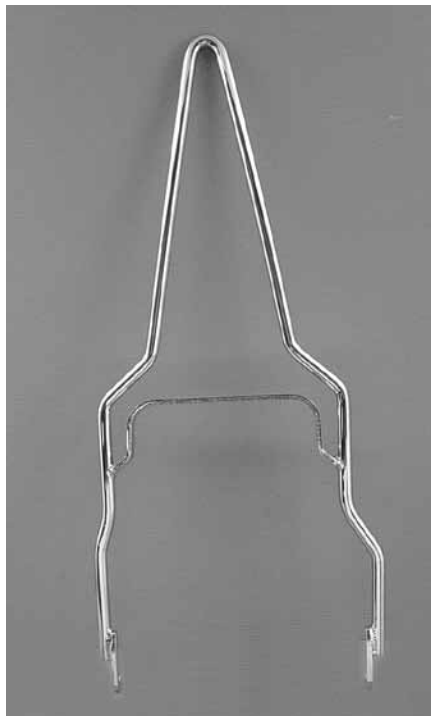

**Chrome Round Sissy Bar**  
 Is constructed of 5/8" steel to fit 8-9" flat fender with belt drive. Height is 30".  
**55810**



**59681**

## Chrome Fender Brace with Offset

Brace for 9" fenders features an offset for pulley and wide wheel.

**PCP Finish**

**59680** Raw

**59681** Chrome



**59680**

# Rigid Sissy Bars

**Chrome 9" Flat Rigid Fender Brace**  
27356

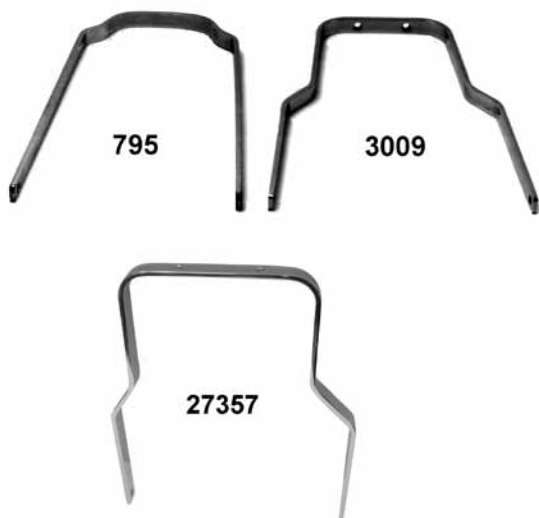
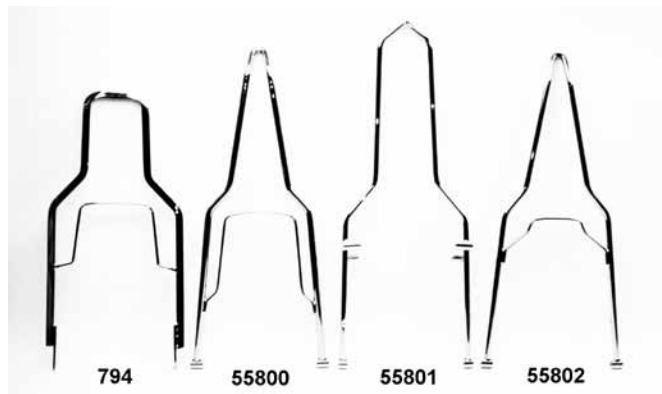

## Rigid Frame Sissy Bars

Manufactured from 9/16" square steel then polished and chrome plated. Designed for Fatbob or 5" & 6" steel fenders.

Note: height is measured from bottom of bar to the top.

PCP	Style	Type	Height	Stock
794	Square Top	Fatbob	23"	Square
55800	Tilt Top	Fatbob	28"	Round
55801	New Style	Fatbob	28"	Round
55802	Pointed Top	Flat	26"	Round

Note: Tire to fender clearance must be checked.

## Chrome Rear Fender Support Braces

Steel 1/4" fender braces for 5" or 6" flat fenders or Fat Bob rear fenders when installed on rigid frames.

- 3009 For Fat Bob fender
- 795 For 5" or 6" flat fenders #6084 and #6085.
- 27356 For flat 9" chrome
- 27357 For flat 8.5" chrome



## Round Sissy Bar by Paughco

These bars measure 1/2" round are 24" tall and 10" wide at the bottom for belt or chain applications.

- 55803 Bobbed
- 55804 Flat fenders, 5" and 6"

## Flat Rigid Fender Braces-Raw

Looks like PCP# 3009 from above, 1/4" steel with preformed bends for flat fenders.

PCP	Size
27288	7"
27289	8"
27290	9"



## Rubber Washers (20 pack)

Use to mount accessories to fender

- 23059 1/4"
- 23060 5/16"

# Rigid Fenders

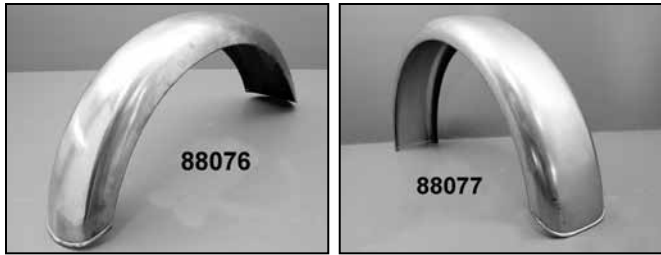

## Heavy Duty Flat Fenders

These fenders are rolled of 16 gauge steel. The wide width of 7"-9" may require trimming for chain/belt relief.

PCP	Description
6084	6" Plain
6085	5" Plain
88300	6" Plain Bobbed
88301	7" Plain
88306	7.5" Plain
88302	8.5" Plain
88303	9" Plain
88304	7.5" Plain Bobbed
88305	8.5" Plain Bobbed



## Round Profile Chopper Fender

British style round fenders have a raw finish.

PCP	Width	Type
88076	5"	Smooth
88077	6"	Smooth
88078	7"	Smooth
88079	7"	Centre rib



## Flat Washers

For mounting fenders and rails. Measures 1-1/4" diameter with a 5/16" bolt hole.

20505 10 pack

## Plain Raw Bobbed Flat Fender

Fenders feature rolled 16 gauge steel construction that may require trimming and finishing for chain relief. Note: these fenders have a depth of 1-7/8".

PCP	Width
88304	7.5"
88305	8.5"



## Rigid Frame Fender Clamp Set

Rigid frame fender U-clamps. Set of 2 chrome clamps & bolts mounts fender to frame behind battery.

941 Chrome (59800-36)

# Front Fenders



## Narrow Front Fender for Wide Glide® & FXST

A trim, tire-hugging fender complete with chrome brackets and ready to paint. A reproduction of the Original Equipment front fender to fit all FXWG 1980-86, FXST 1984-02 and FXDWG 1993-02. OEM 59924-80

- 6088** Unpainted
- 6089** Chrome



## Stock Type Front Fender 1984-91

- 88212** 59007-84



## 2000-on FXSTD Steel Front Fender

- 88231** Raw with chrome bracket (59876-00)



## Narrow Front Fender

Custom front fender for all FX, FXR and Sportster® models with 35mm or 39mm front forks from 1973-02. Unpainted, and complete with assembled chrome or plain brackets. Use with 18", 19" or 21" rims.

### PCP Description

- 6009** Unpainted with chrome brackets (59031-83)
- 88210** Unpainted with plain brackets (59031-83)
- 88224** FXLR 21", 1991-on XL 19" (58998-83)



## FXWG-FXST Glide Type Fender 1980-on

- 88221** 59924-80



## FXSTS Front Fender

- 88209** 1989-92 Springer models (raw-oiled w/chrome brackets) (59176-88)



## Custom Narrow Fender for Dyna Wide Glide

Fits 2006-on FXDWG models and features chrome brackets.

- 88067** 60141-06



## Conversion Fender Spacer Kit

This chromed fender spacer kit includes hardware to allow the use of any stock narrow glide fender on a 41mm Wide-Glide front fork. Spacers bolt to the slider assembly.

- 43120**

# Front Fenders



## FL-Style Fender for FXWG & Softail®

Fender for 16" front wheel as on (Wide Glide® front ends), this high-quality metal fender comes with a raw oiled finish. Fits FXWG, FXST/C and Dyna WG 1980-99. If trim is desired, mounting holes must be drilled and trim is available separately.

**88200** Unpainted



## Late FLH Front Fender

### Front FLH & FLT Stock Replacement Fender

Has trim holes and hole dimple in front for light.

**66902** 1987-99 T/L primered (59093-87)

**88026** 1987-99 FLT (Preston, not primered)



## FL Touring Front Fender

Primered fender has no holes for easy custom use and will bolt on to existing brackets on 1994-on FLHR, 1989-on FLT, FLHT and FLTR/HX/HRS models.

**66910** T/L (59045-00B)



## FLHT/C/I Front Fender 2000-on

**66908** T/L as stock primered (59093-00B)

**88240** Preston as stock (not primered)

**88241** Preston as above without holes



## FLSTS Stock Skirted Front Fender 1997-on

**66909** T/L Primered (59164-97A)



## Front Fender Rail Light Kit

Increase your visibility using our 12 volt amber running lights that mount to the front fender rail on FL, FLT and Heritage Softail models 1973-on. Installation is quick and easy, just wire the kit to the stock fender tip light. Sold in pairs.

**28305**

# Front Fenders

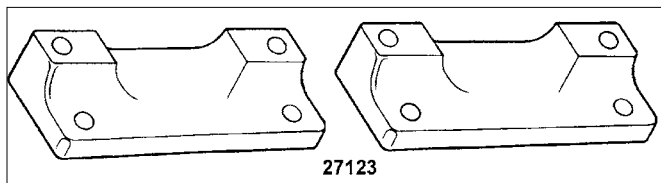

## Fender Adaptor Brackets

Allows the installation of a narrower Fat Kid (FLST style) front fenders on 1980-99 FLT-FLHT with 16" front wheels.

### PCP Application

- 27123** 1980-99 Alloy
- 27354** 1980-99 Chrome billet
- 27376** 2000-on Chrome (59013-02) (not w/fairing lowers)



## Touring Front Fender Adaptor Kit 2000-on

Chrome plated polished billet aluminum adapter kit lets you install a Fatboy style front fender onto 2000-on Touring models and Road Kings. Will not fit Touring models with fairing lowers.

- 29218** 59013-02

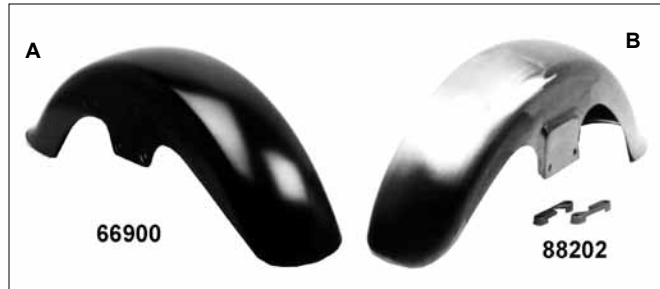

## Steel Front Fender For the Fat Boy Look

Steel front fender for Fat Boy® models 1990-99. and most FL, FXWG, and FXST models when a 16" wheel is used.

### PCP Application

- 66900** (A) FLSTF, FLST 1990-99 w/primer T/L (59139-89)
- 88018** (A) Preston as above, (no primer)
- 88242** Preston as above (no primer) but with welded brackets (no rivets showing)
- 66905** (A) FLSTF, FLST 1997-99 (59139-97) T/L
- 88229** (A) FLSTF 2000-on (59139-00) T/L
- 88213** (A) FLT 1980-on (Preston, no primer)
- 88208** (B) FXWG, FXST 1980-99 (Preston, no primer)
- 88202** (B) 1949-84 FLH (Preston, no primer)



## Wide Glide fenders for FLSTC 1986-99

Two versions offered for Heritage Softail models 1986-99. #66904 is ready for stock replacement with proper fender light and trim holes while #88203 does not have light relief or trim holes. Fenders are not painted.

- 66904** Stock replacement (59129-86)T/L
- 88204** Preston as above,(not primered)
- 88203** Preston, with no trim holes (not primered)

# Front Fenders

**NOTE!!! THESE DO NOT FIT WITH 16" TIRES**



6071



88216

88215

## Spring Fork Style Fenders

Classic springer style 5" wide for 19" wheels for most models. Give a classic look to the new machines. Assembled using rivets.

PCP	Application
6071*	FX 1973-85, FXR 1982-90, XL 1973-90 19" tires
6072*	FL models 1949-on 19" tires
27284	Spacer set for above
88215	Fender only (no braces)
88216	FXSTS 1988-92

\*Note: These numbers are supplied with chrome braces.

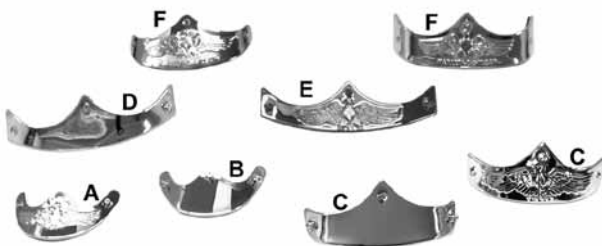

## Chrome or Brass Fender Tips

Beautifully crafted fender tips in chrome or polished brass, with eagle or no eagle.

Fits fender width as noted.

PCP	#	Style	Width	Type
59344	A	Eagle	4"	FXWG-FXST
56222	B	Smooth	4"	As above
59345	C	Smooth	5"	FX
2187	C	Eagle	5"	FX
2186		As above in polished brass		
56220	D	Smooth	7"	1936-57 BT
2185	E	Eagle	7"	1937-57 BT
2184		As above in polished brass		
29657	F	Eagle	6 1/2"	1990-on FLST, Front
29658	F	Eagle	7"	1990-on FLSTF, Rear

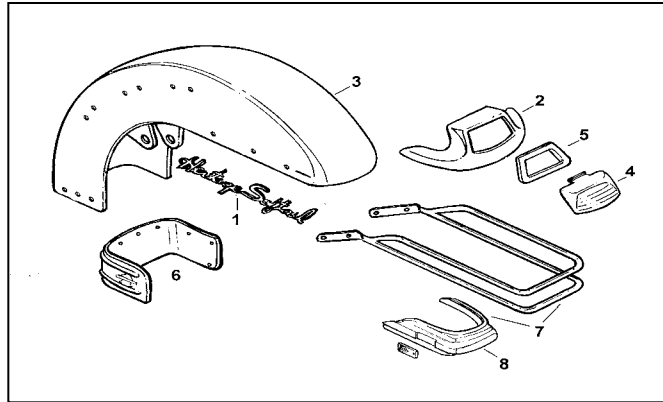

## Front Fender & Trims

	PCP	Description
1	29622	FLST/C Heritage 1986-on (14142-86) (ea)
	29623	FLHTC/U Ultra-Glide 1989-on (59236-89) (ea)
	29624	FLTC/U Ultra-Tour 1889-on (59246-89) (ea)
2	29520	Fender light compl.1987-on 59082-79)
3	66902	FLT F/Fender prime1987-99 (59093-87A)
	66904	FLSTC F/Fender (prime) 1987-03 (59129-86)
	66900	FLSTF As above 1990-99 (59139-89)
	88229	FLSTF 2000-on (59139-00A)
4	29511	Lamp lens 1980-on, amber (59180-80)
5	25192	Lamp gasket 1980-on (59181-80)
6	29620	FLT F/Fender trim 1987-06 (59231-86)
	29621	FLST/C Black fender trim 1987-06 (59235-86)
7	29630	FLT 1983-06, FLHS 1987-93, FLHT 1996-on, FLHR 1994-on F/Bumper assembly (91085-83C)
8	29631	FL Bumper only 1977-on (91107-77B)

**All front fenders and trims are made in the USA except #29520 fender light from Taiwan**



## Chrome Front Fender Mounting Kit

Reproduction of stock Harley hardware used to install stock fenders.

PCP	Description
24072	FLST 1986-on
24073	FXWG, FXST 1980-93
24074	FXST 1994-on w/acorn nuts

# Front Fenders

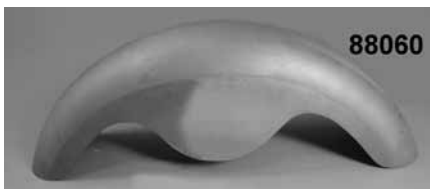
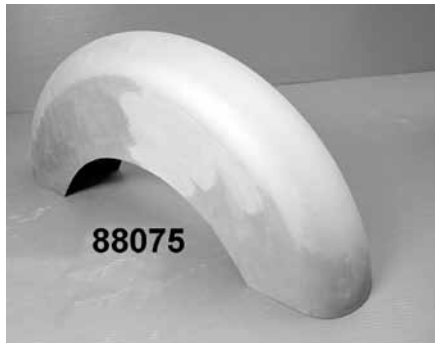
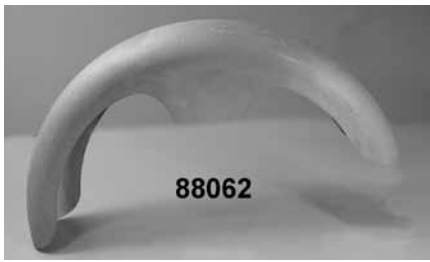

## Wyatt Gatling Steel Front Fenders

Laser cut from full one piece blanks. Spacers required for use on 41mm glide forks for 19" or 21" wheels. Note: We suggest pre-fitting all fenders before painting. All fenders require determination of hole location and drilling to mount.



PCP	Coverage (Degrees)	Wheel	O.D. of Bracket	Inside Width
88069	140	19"	5-1/2"	4-3/4"
88060	140	19"	7"	6-1/4"
88062	168	19"	5-1/8"	4-7/8"
88071	168	19"	5"	4-7/8"
88072	168	19"	4-7/8"	4-3/4"
88073	180	21"	7"	4"
88074	140	19"	5-1/2"	4-3/4"
88075	180	19"	5"	4-7/8"



## Chrome Fender Mounts

Are .750 thick to mount custom fenders to wide glide forks.  
27355 Pair

# Rear Fender



## Fat Bob Rear Fender Kit for FXR Models

A complete Fat Bob Rear Fender Kit for all **FXR models from 1982-86 and 1987-92 FXRTs**. The rebellious upswept kick of the chopper-style rear fender is combined with our smooth, chromed steel fender struts that not only improve styling but provide improved fender support over the original equipment parts. Accepts all of PCPI's taillight kits with Fat Bob mounts, or the stock (OEM 59993-80) taillight bracket. This kit and its components are not compatible with Original Equipment or aftermarket sissy bars.

**6024** Unpainted fender kit

**Note:** These fender struts are not designed for the standard Original Equipment fender, nor will this fender mount correctly to the standard fender struts.

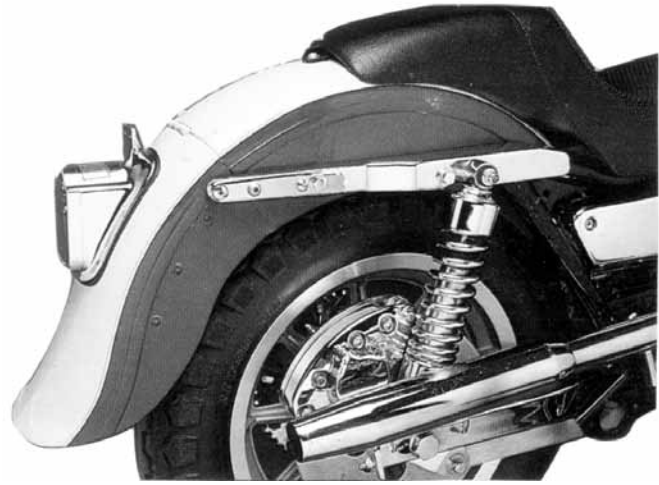

## Flip Rear Fender Kit for FXR

Combines the time-proven styling of the classic dresser rear fender with the latest rubber-mount motorcycles. This flip-up rear fender fits all FXR models from **1982-86, and 1987-92 FXRTs**. The flowing lines of the fender are combined with special-design struts to smooth the rear styling and provide improved support. The fender and struts are sold as a kit—designed from the ground up as a combined, quality installation. This kit and its components are not compatible with Original Equipment or aftermarket sissy bars.

**6023** Unpainted fender kit

**Note:** These fender struts are not designed for the standard Original Equipment fender, nor will this fender mount correctly to the standard fender struts.



## FXR Stock Type Rear Fender

**PCP Application**  
**88028** 1982-99 FXR-FXRS models



## FXR Dresser Style Rear Fender

Steel fender bolts to stock struts on 1982-94 models.  
**88030** With tail light cut



## Chrome Rear FXR Fender Struts

Diecast as stock and then an excellent chromed finish.  
**57407** 1982-86 FXR (not 1983-91 FXRT, FXRP (59500/1-84))  
**57403** 1987-on FXR (not FXRT, FXRP) (59542/4-87)

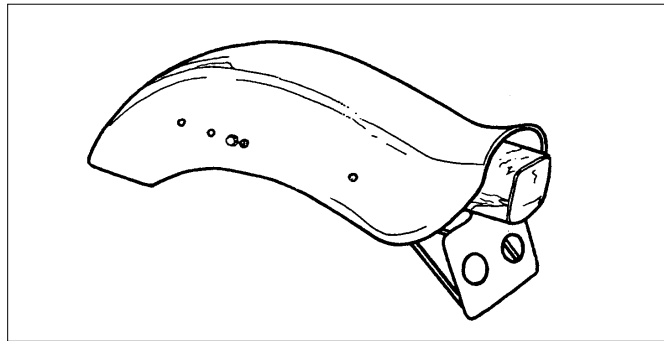

## FXR Rear Bobtail Fender Kit 1982-94

Kit includes steel fender and a tail light bracket to accept the stock 1973-on tail light and mounts FXWG style as shown.  
**88008** Kit

# Rear Fender



66954



66964

## FLSTF Rear Fender

One piece fender can also be used on all FLT 1986-on. Accepts #406 tail light.

### PCP Application

- 66954** 1990-95 USA (59596-89)
- 88027** Preston as above (no primer)
- 66962** 1996 USA (59596-96)
- 66966** 1997-99 USA (59754-97)
- 66975** 2000-on USA (59596-00A)
- 99220** Chrome struts 1986-99 (59964-86, 59969-86)
- 99223** Chrome struts 2000-02
- 23039** Grommet for wiring 1986-99



66964

## FLSTS Style Fender Kit

Kit includes steel fender, tombstone taillamp, and license plate bracket for 1996-99 FXST and FLST models.

**66964** 59662-97 (USA primered)



## Saddlebag Filler Insert Kits

These inserts fit in the spaces between the back of the saddlebags and the fender which stylishly hides the saddlebag mounting bracket. Will fit 1993-08 Electra-glides (not FLHX), 1994-08 FLHR (except FLHRS, FLHRCI). Will not fit with leather bags (90652-94, 90843-93), electra glo rails, triple rail bag rails or saddlebag guard kit (90839-93A, 91216-97).

### PCP Finish

**64205** Chrome (45898-98)

**64206** Black (45898-06BKL)

\* Not for use with long rails or 1998-on FLTR



## Rubber Wire Grommets

Grommets can be inserted into fender to protect wiring.

**23039** (11430) (10 pack)



## Slotted Filler Strips

Fits 1995-08 Electraglide (not FLHX), 1994-08 FLHR (not FLHRS). Will not fit FLTR and FLHRCI with rear detachable docking kit. These strips fill the area between the fender and saddlebag. Will not fit with leather bags (90652-94, 90843-93), electra glo rails, or bag rails (90839-94, 90845-93).

**64203** Chrome (45896-98)

**64204** Black (45897-98)

\* Not for use with long rails or 1998-08 FLTR

# Rear Fender



66972



## FXST Rear Fender 1997-99

88031 59753-97

## FXD Rear Fenders

PCP	Application
66972	1990-95 USA (59634-90A)
66973	1996-98 USA (59634-96)



66970

66971



66958

## FXDWG Rear Bobbed Fender

PCP	Application
66970	1992-95 (59918-92) USA
66971	1997-01 (59918-97A) USA

## Bobbed Rear Fender Kits

Kits for FXD-FXDL models include a primed fender, supports, license plate bracket, reflectors and mounting hardware.

PCP	Application
66958	1996-98 USA (59656-97)



## FXST Style Rear Fender Kit

Kit fits 1986-99 and includes steel fender, chrome struts in smooth or stock style, chrome license plate bracket and tail-light with hardware.

88035	Stock struts
88048	Smooth struts

# Rear Fender



## Hinged Rear Fenders for Softail® Models

We offer Heritage-style rear fenders with hinges. They're available in tail light version which fit the OEM struts of all Softail® models 1984-96. Also custom smooth version with no taillight mount permitting the use of your tail light choice.

**6001** With no taillight mount (59126-86)

**88013** With 1973-on taillight mount



## Chrome FXST-FLST Rear Fender Struts (USA)

**PCP** **Fitment**

**66960** Left and right FXST, FXSTC, FXSTS 1986-on (59954-86A, 59955-86A) (shown at top of picture)

**66961** Left and right FLST/C 1986-99 (59969-86A, 59964-86A) (shown at bottom of picture)

**21507** Chrome mount bolt kit 1986-99 FXST



## Rear Fender Strut Mounting Kit

Chrome low profile allen hardware kit.

**9920** Mounts 4 hole struts on 1986-on 5 speed Heritage Softail or Fat Boy (59969-86)

**9921** Mounts 6 hole struts on 1986-on FXST/C/S and Bad Boy (59954-86)

**72043** FX-FL Softails 2000-on (except Deuce)

**72044** Buttonhead bolts, as above

**72268** Sportster 2004-on

## Rear Fenders for Heritage Softail® & FLSTN

Features turn signal mounting holes, taillight mount, and fender reveal. Ready to use as an Original Equipment replacement or for FXST models wanting to change over to full one-piece fenders. Unpainted.

**PCP** **Description**

**66950** Stock style Heritage Softail® 1987-96 (59144-87A) USA

**88010** Preston as above, (no primer)

**88011** Smooth style Softail® 1987-96 as a custom fender. No taillight holes

**66963** Stock style 1997-99 USA (59755-97) USA

**99220** Chrome fender struts 1986-99 (pair)

**66969** Stock style FXST 2000-02 USA

**66976** Stock style FLST 2000-05 USA (59144-00)

**99223** Chrome fender struts 2000-02

**27278** Plastic fender splash guard 1984-99 (59648-84A)



## Fat Bob Rear Fenders for FXWG & Softails®

Reproductions of the OEM pieces. Both fenders include the wire loom clips and necessary strut mounting holes as stock. They accept stock taillight assemblies as well as 'Cateye' and 'Lucas' taillights/brackets as found in Section 3.

**Fenders**

**PCP** **Description**

**6006** 1980-86 FXWG Preston (59904-80)

**66955** 1986-96 FXST/C and FXSTS USA (59914-86A)

**88017** Preston as above (no primer)

**27278** Plastic fender splash guard for FXST (59648-84A)

**99221** Chromed struts for FXST fenders USA

**88031** FXST 1997-99 (59753-97)

**88233** FXST 2000-on

**Taillights and Brackets**

**28510** Black taillight bracket (59993-80)

**28511** Chrome taillight bracket (59993-80TA)

**406** Stock taillight assembly (68008-73A)

**1231** Custom Fat Bob taillight bracket assembly

# Rear Fenders



88021

## EZ Bob XL Rear Fender Kit 1982-on

Kit includes a steel fender, cateye taillight, and chrome light bracket to fit stock struts. If required, chrome struts and covers are available separately.

### PCP Application

88020	1982-93
88021	1994-03

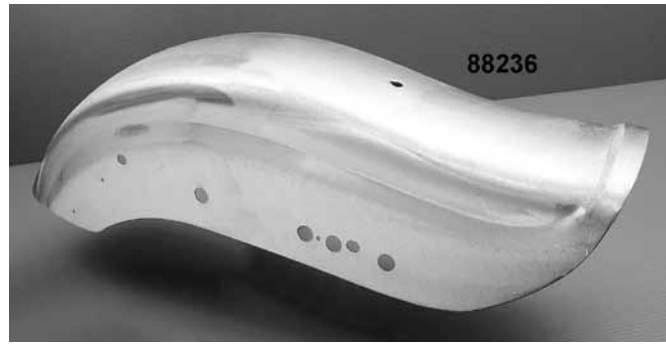

88236

## Sportster Bobbed Rear Fender 1991-03

Mounts to stock strut bars.

88236 With holes



## Sportster E-Z Bob Rear Fender 2004-on

88029 Primered (59985-04)

## T/L Sportster Bobtail Fender Kit

Custom styled Bobtail fender fits 1999-on XL models. Use of this fender requires the separate purchase of installation kit #69704-00 or 60081-00.

66984 Primered finish (60025-01)



66953

**Note: Always install fenders for proper fitting before painting.**

## Rear Fenders & Trim

PCP	Description
66950*	Fender FLSTC/N 1987-96 (59144-87A)
66953*	Fender FLT 1985-90 (59579-85)
66979*	Fender FLT 1991-98 (59579-91A)
66954*	Fender FLSTF 1990-95 (59596-89)
29521	Rear lamp assembly FL 1979-on (59658-79)
66955*	Fender FXST 1986-96 (59914-86A)
29512	Rear lense FL 1980-on (68046-79)
25197	Rear lense gasket FL1980-on (68047-79) (5 pk)
66985*	Fender FLT 1999-on (59579-99B)
* USA	



## Custom Fender Mounting Kit for Softails®

This kit replaces the stock mounting hardware on FXST models 1984-99. Provides a clean, custom look. Kit includes 6 each chrome diecast covers, socket head bolts, washers and lock nuts.

45300 Kit

# Fender/Struts



**9" Rear FXST Fender 1986-99 (no holes)**  
88025



**T/L Softail Chrome Rear Struts 2003-05**

- 99225 FXST, FLSTF (59964/9-03)
- 99226 FLST (59954/5-03)



**FXR Rear Fender 1982-99**  
88028 59634-81A



**11" Strutless Fender for a 250 Rear Tire**  
Inside front mount measurement is 11-1/4" and front to back length (over curve) is 34-1/4".  
88065

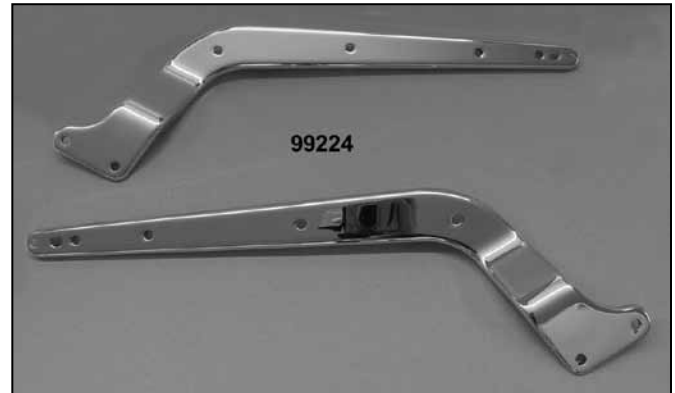

**Replica Chrome Rear Strut Sets 2000-02**

- | PCP   | Application                          |
|-------|--------------------------------------|
| 99228 | FXST 2000-05                         |
| 99229 | FLST                                 |
| 99230 | FLST smooth                          |
| 99223 | FXST stock, T/L (59964-00, 59969-00) |
| 99224 | FLST stock, T/L (59954-00, 59955-00) |

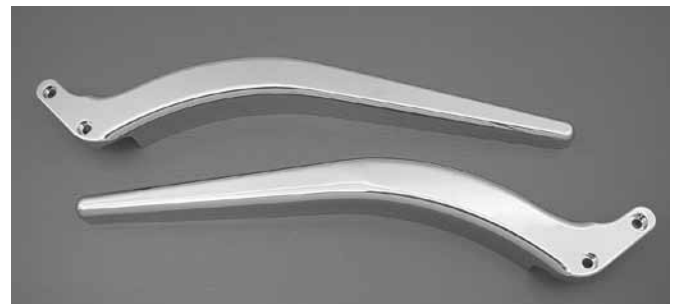

**FXST Curved Strut Set**  
99227 Fits 9" fenders on FXST models

# Rear Fenders

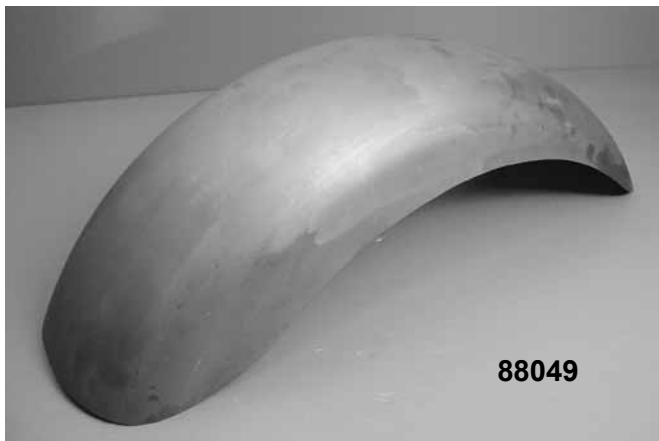

88049



88053



88051



**Custom Fender Mount Kit**  
Includes rubber bushings.  
24104



## Custom Steel Fenders by Wyatt Gatling

Smooth formed, undrilled fenders are perfect for the builder's custom applications.

### Rear

PCP	Width	Length	End to End
88049	9"	34"	27.5"
88051	9.5" with brace	38" rigid	29"
88053	9"	41"	32"
88068	12.75"	38"	27.5" left belt

### Measurement Note:

Length is measured from tip to tip across the top of the fender and end to end length is measured along the side of the fender.

# Wide Rear Fenders



88024

## 9" Wide Bobbed Steel Rear Fender

Fits FXST struts when used on wide style frames 1986-99.

- 88024 With holes
- 88025 Without holes

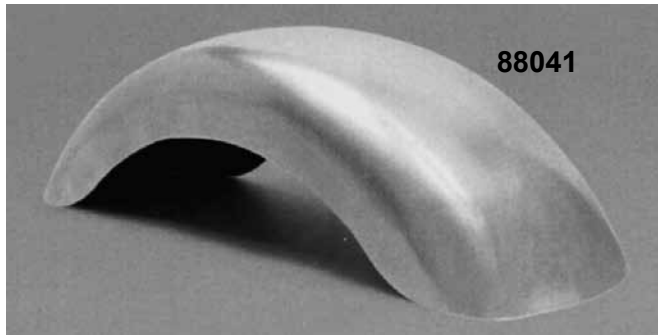

88041

## Custom Round Profile Fenders

Raw steel.

- PCP Width
- 88039 9"
- 88041 11" x 34.5"



88044



88045



88047

## FXST Strutless Rear Fenders

Fit frames when width is 11 inches where original struts attach. Length measurements are taken from the front flat area to the end. PCP# 88045 weighs 21 pounds.

PCP	Width	Tire	Length
88044	9"	200	
88045	9"	200	34-1/2"
88047	11"	250	28"



## Rigid Rear Fender Brace Set

Two piece design can accommodate any width fender.

- PCP Finish
- 59257 Chrome
- 59258 Raw



59680

59681



88047

## Chrome Fender Brace with Offset

Brace for 9" fenders features an offset for pulley and wide wheel.

- PCP Finish
- 59680 Raw
- 59681 Chrome

# Sportster Rear Fenders

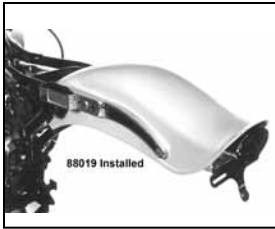

## E-Z Bob Rear Fender Kit for Sportster® 1982-on

Kit includes a steel fender and a Cateye taillight assembly with mounting bracket. This fender kit looks especially good when combined with the one-piece Sport Bob™ gas tank found in section 9. Order struts separately.

- 88020** Fender kit 1982-93
- 88019** Fender only 1982-93
- 88021** Fender kit 1994-03



## Rear Sportster Steel Fenders 1982-on

- | PCP          | Description  |
|--------------|--|
| <b>6079</b>  | Plain rear replacement fender with taillight mount 1982-on XLS (59674-79A) |
| <b>6554</b>  | 1982-93 (59674-81C)  |
| <b>66981</b> | Stock 1994-96 (59674-94A) USA  |
| <b>66983</b> | Stock 1999-03 (59674-99) USA   |
| <b>88080</b> | Preston as above   |



## T/L Sportster Bobtail Fender Kit

Custom styled Bobtail fender fits 1999-03 XL models. Use of this fender includes the installation kit #69704-00.

- 66984** Primered finish (60025-01)

## XL Chrome Rear Fender Supports

- 6479** 1982-89 Chrome (59950-81 & 59951-81) (pair)
- 57400** 1990-93 Chrome (59950-89 & 59951-89) (pair)
- 24039** Allen bolt set for above struts



## XL Steel Rear Fender 2004-on

Stock style fender replaces 59847-04.

- 88239**

## Chrome Rear FXR Fender Struts

Diecast as stock and then an excellent chromed finish.

- 57407** 1982-86 FXR, 1983-91 FXRT/P (59500/1-84)
- 57403** 1987-94 FXR, (not FXRT/P) (59542/4-87)



## XL Chrome Strut Covers 1982-on

Chrome plated covers fit over existing shock struts.

- | PCP          | Application          |
|--------------|----------------------|
| <b>45224</b> | 1982-89 (59243-95)   |
| <b>45187</b> | 1990-93 (59241-95)   |
| <b>45225</b> | 1994-03 (59897-94)   |
| <b>45226</b> | 2004-on (59902/3-04) |

**ADVISORY\*\*\***  
**ALWAYS INSTALL FENDERS BEFORE PAINTING,**  
**TO MAKE SURE OF FITMENT.**

# Rear Fender Struts



## Rear Chrome Fender Struts (USA)

- | PCP          | Description (sold in sets)                                    |
|--------------|---|
| <b>27215</b> | Strut support set Dyna 1991-95 (zinc) (59112-90, 59113-90)    |
| <b>82021</b> | Struts FXDL, FXD 1993-95 (59138-93, 59171-93)                 |
| <b>82024</b> | Struts FXDWG 1993-95 (59893-93, 60007-93)                     |
| <b>82025</b> | Covers, left and right FXDWG R/S 1996-00 (59893-96, 60007-96) |
| <b>82022</b> | Struts FXDS-CON 1994-95 (59167-94, 59136-94)                  |
| <b>82023</b> | Struts FXD/L/S-CON 1996-05 (59171-96, 59138-96)               |
| <b>82026</b> | Black struts FXSTSB 1995 (59881-95, 59880-95)                 |



## FXST, FLST Rear Fender Extension 1986-on

- Replaces stock plastic extension.
- |              |                                    |
|--------------|------------------------------------|
| <b>27279</b> | Stainless steel 1986-99 (60401-98) |
| <b>27287</b> | Curved chrome 1986-99              |
| <b>27309</b> | Stainless 2000-07 (60476-00A)      |
| <b>12633</b> | Speed nuts                         |
| <b>27359</b> | Chrome 2000-on                     |



## Chrome FXST-FLST Fender Struts

- | PCP          | Fitment                                  |
|--------------|--|
| <b>99220</b> | FLST/C 1986-99 (599694/9-86A)            |
| <b>66961</b> | T/L as above, original style             |
| <b>99221</b> | FXST, FXSTC, FXSTS 1986-99 (59954/9-86A) |
| <b>99222</b> | Left & Right "smooth" 1986-99            |
| <b>99223</b> | FXST stock 2000-02 (59964/5-00)          |
| <b>99224</b> | FLST stock 2000-02 (59954/5-00)          |
| <b>21507</b> | Chrome mount bolt kit FXST 1986-99       |



## Rear Fender Strut Mounting Kit

- Chrome low profile allen hardware kit.
- |              |  |
|--------------|--|
| <b>9920</b>  | Mounts 4 hole struts on 1986-on 5 speed Heritage Softail or Fat Boy (59969-86) |
| <b>9921</b>  | Mounts 6 hole struts on 1986-on FXST/C/S and Bad Boy (59954-86)                |
| <b>72043</b> | FX-FL Softails 2000-on (except Deuce)  |
| <b>72044</b> | Buttonhead bolts, as above   |

# Rear Fender Struts



2915



57408

## Chrome Fender Strut Set

All sets are pre-drilled with the correct mounting holes. Installation of FXWG style struts on FX 4-speed models will permit mounting of wide FL tailgate or FXWG "bobbed" fenders.

**2915** FXWG 1980-86 3 holes, back hole is countersunk  
**57408** As above, less turn signal holes



24013



24014

## Chrome Allen Fender Strut Bolt Kits

Kits include allen head bolts, washers and nuts for mounting fender.

PCP	Description
21507	FXST 1986-99
24013	FXWG 1980-85
24014	FX 1973-85
24039	XL 1979-on



## Chromed Rear Fender Support Mounting Kit

Duplicate of stock OEM hardware.

PCP	Fitment
21513	FXST, FLST 1986-99, stock

## Custom Mounting Kits

1734	Acorn kit FX 1971-86
2899	Cap kit, as above
72045	Acorn, FXST 2000-on



## Internal Mounting Fender Struts

All sets are polished and chrome plated. Can be used to mount custom, reproduction or OEM fenders. Installation of FXWG style struts on FX 4-speed models will permit mounting of wide FL tailgate or FXWG "bobbed" fenders.

**4856** FXWG 1980-86



4844



29621



45186

## Lower Ribbed Front Fender Trim

Chrome ribbed lower fender trim is shaped to match the stock front fender.

PCP	Application
4844	FL 1949-85 (2 1/2") (59233-68)
45186	Touring models 1980-on, FLSTC/N 1986-on (3 1/4") (59228-91)
29621	Polished w/blk trim FLST 1987-06 (59235-86)



4845

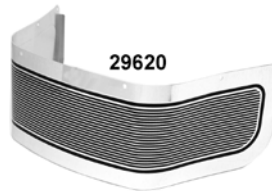

29620



45185

## Chrome Front Lower Fender Trim

Chrome plated with a smooth finish and fits all FLH.

PCP	Application
4845	FL/T/HT/HS 1958-85 (59233-76)
29620	FLT, FLH/T/S 1987-06 (2 1/2" tall) (59231-86)
45185	FLST/C, 1987-06 (3 1/4" tall) (59235-86)

# Fender Trim



## Eagle Front Fender Ornaments

These diecast fender ornaments are highly detailed and available chrome version. Mounting bolts and gaskets are included. The smaller version measures 6-3/4" long and 1-1/2" wide and 2" tall.

**40300** Chrome



## Diecast Fender Skull Ornaments

Top quality fender trim with or without illuminated eyes. They are offered in all chrome or a chrome and gold inlay. Definitely something different to set your bike apart.

**40312** Chrome with illuminated eyes

**40313** Chrome with gold inlay and illuminated eyes



## Front Fender Lamp 1949-on

**19393** Clear lense (68450-49)

**19394** Amber lense



## Chrome or Brass Fender Tips

Beautifully crafted fender tips in chrome or polished brass, with eagle or no eagle.

**PCP Model**

**56220** Wide FLH

**56222** FXWG, FXST, XLX front

**2187** FX, XL front (59280-85T)

**2186** As above in polished brass

**2185** Wide FLH (59282-85T)

**2184** As above in polished brass



## 3/8" x 11" Chrome Trim Kit

Comes with trim (2), studs, washers, nuts and krommets. **403**

## 3/8" x 11" Chrome Curved Trim Kit

Fits surfaces such as fenders. Comes with krommets, studs, washers and nuts. **404**



## Front Fender Stanchion Kit

**64262** FL Softail 1984-on and Touring 1980-on (except FLSTF, FLSTSB) (91117-97)

# Fender Trim



**T/L FLSTF Fender Trim with Wings 1990-on**  
Stylish chrome accent features eagle wing motif and is available with chrome or gold wing.

PCP	Description
29660	Rear gold 1990-06 (59369-97)
29661	Rear chrome 1990-06 (59368-97)
29662	Front gold 1990-on (59367-97)
29663	Front chrome 1990-on (59366-97)

29664



29657



29658



**T/L FLSTF Fender Trim with Wings 1990-on**  
Stylish solid brass accent features eagle motif available in chrome or gold. Includes mounting hardware and foam pad.

PCP	Description
29664	Front gold 1990-on (59318-96)
29657	Front chrome 1990-on (59285-90)
29665	Rear gold 1990-06 (59317-96)
29658	Rear chrome 1990-06 (59286-90)

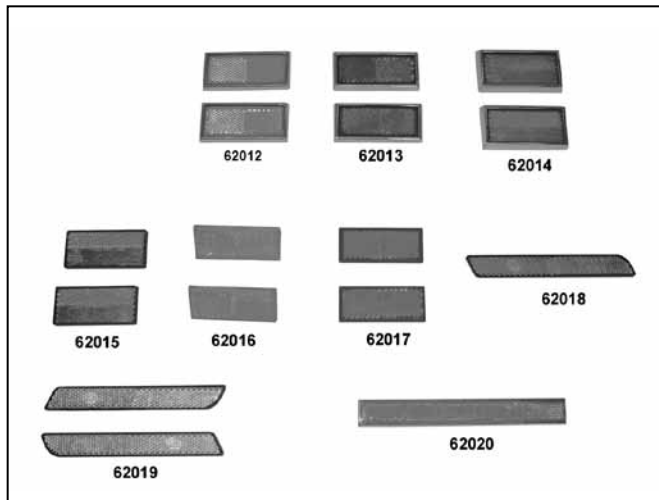

## Reflectors

Adhesive Backed OEM type, DOT approved

PCP	Colour	Description
62012	Amber	F/fender 1987-93 FLSTC, FLHS (framed) (59254-91) (pair)
62013	Red	R/fender 1972-on FX, 1987-91 FXST (59255-72) (pair)
62014	Red	R/fender 1993-on FXSTC/S/F (framed) (59255-91) (pair)
62015	Red	R/fender 1990-93 XL, 1991-92 Dyna and FXR's (59259-90) (pair)
62016	Amber	<b>Non-adhesive</b> , pin type, f/bumper 1980-93 all FLT's (59261-77) (pair)
62017	Red	R/fender 1979-89 XL, 1982-90 FXR's (59263-79) (pair)
62018	Red	R/S rear fender and L/S rear fender 1992-93 FXR's, Dyna, FLSTC/N (59287-92, 59288-92)(sold as a set)
62019	Amber	R/S fender and L/S fender 1992-on Dyna (59289-92, 59290-92) (set)
62020	Red	Rear tail light bracket (59988-72) (each)



57100

57101

## "Skull" Fender Mudflaps

Both mudflaps are black with a white imprinted skull emblem that has red reflector eyes. Both measure 6 1/2" wide at the 3 fender mount holes (hardware included).

57100	Large size (bottom 10 1/4" wide by 8" high)
57101	Small size (bottom 9 1/2" wide by 6 1/2" high)



61216

61215

## T/L Adhesive Medallions

The cast medallions feature a high quality finish and an adhesive backing that allows them to be pressed onto most flat surfaces. These sophisticated designs look especially sharp on backrests and battery covers.

PCP	Size	Design
61213	3-5/8" x 3"	Chrome skull (91718-02)
61215	5" x 1-1/2"	Chrome skull with wings (91723-02)
61216	5" x 1-1/2"	Antique nickel skull with wings (91732-02)

# Fender Trim



## T/L Chrome V-Logo Fender Skirt

Die-cast aluminum V-logo, ribbed fender skirt includes mounting hardware. Fits 1980-on Touring models, 1986-on FLSTC, 2006 FLST and 1993-96 FLSTN models equipped with original style fender skirt.

**29638** 59146-96



## T/L Rigid Steel Front Fender Skirt with Emblem

Chrome ribbed fender skirt features stamped, ribbed emblem for sophisticated styling. Fits 1980-on Touring models, 1986-on FLSTC, 1993-96 FLSTN models and 2006 FLST equipped with original style fender skirt.

**29640** 59228-91



## Road King Front Fender Skirt

Fits with original fender skirt.

**29635** 1980-on (59005-98)



## T/L Chrome Skull Front Fender Skirt

Chrome ribbed skirt features raised skull motif with black accents and all mounting hardware. Fits 1980-on Touring models and 1986-on FLSTC, 1993-96 FLSTN models and 2006 FLST equipped with original fender skirt.

**29641** 59582-02



## Classic Fender Tips

Made of plastic with a chrome finish and a black accent as stock on Road King models 1998-on. These tips will replace fender lamps. Fits 1980-08 FL, FLHR, 1986-99 FLST, and 1986-08 FLSTC.

**29633** Front (59002-98)

**29634** Rear (59052-98)

Will not work on FLSTF or FLTR models.



## T/L Chrome Concho Fender Skirt

Ribbed fender skirt features ribs and built-in conchos resembling the Heritage Softail Classic. Fits 1980-on Touring models, 1986-on FLSTC, 2006 FLST and 1993-96 FLSTN models equipped with original style fender skirt.

**29639** 59147-96

# Fender Trim

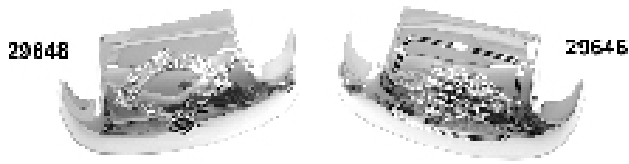

## Flame Fender Tip

ABS fender tip features chrome flame design and includes mounting hardware. Replaces front fender lamp assembly on 1980-on FLT, 1993-on FLHR and 1996 FLSTN. Does not fit FLSTS, FLHRS or FLTR. Rear fits 1980-08 FLT, FLHR, FLSTC, and 1993-96 FLSTN.

**29646** Front (59348-98)

## V-Wing Fender Tip

Fender tips include mounting hardware and fit FLT and FLHR 1980-on.

**29648** Front (59333-97)



## 2000-on FLT Tips With Lights

**29546** Rear with light (59672-99)

**29547** Front with light (68706-00)



## T/L Chrome Skull Fender Tip Lenses

Chrome fender tip lense kit features front amber and rear red lenses with a translucent skull silhouette. Fits 1980-on Electra Glide, Tour Glide, FLHS, Road King (except Road King Calssic and FLHRS) and 1986-08 FLSTC and 1993-96 FLSTN models.

**29642** 59651-01

## LED Fender Tip Lamps

Fit 1980-on models.

PCP	Type	Colour
<b>59340</b>	Rear	Red
<b>59341</b>	Front	Amber

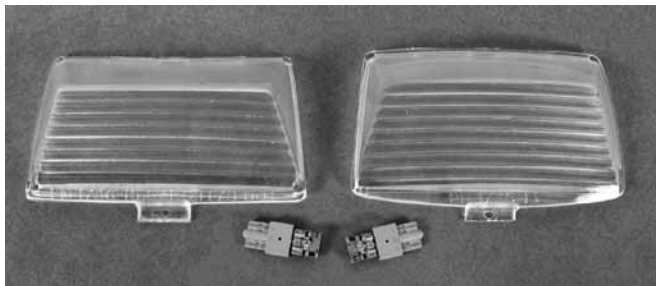

## Clear Fender Tip Lens Kit

Kit includes 2 LED bulbs, 1 red and 1 amber. Fits 1980-08 FLT, FLHR and 1986-on FLSTC and 1993-96 FLSTN (not w/ clean front fenders or Springer FLST, FLHX, FLHRS or FLTR).

**29528** 59381-05

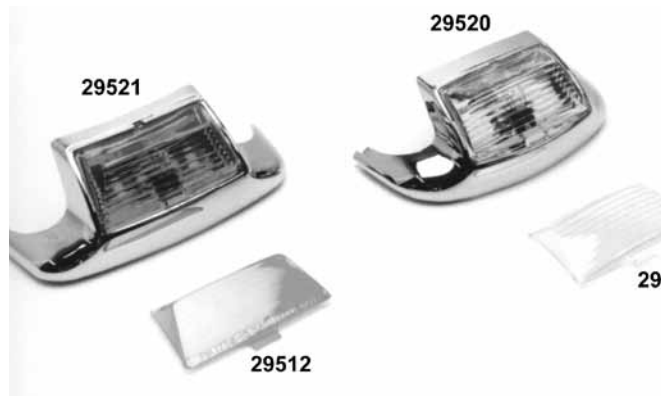

## Lighted Fender Tips

Replaces OEM items on 1979-on FLT in chrome plastic with lights installed.

PCP	Description
<b>29520</b>	Front fender light (59082-79)
<b>29511</b>	Front lens only (59180-80)
<b>29521</b>	Rear fender light (59658-79)
<b>29512</b>	Rear lense only (68046-79)
<b>50016</b>	Front fender tip grill
<b>50017</b>	Rear fender tip grill
<b>50014</b>	Front amber lense with blue dot

# Fender Trim



## T/L Front and Rear Fender Lense Grill Set

Chromed plastic grill set fits front and rear 1980-on FLT, FLHT, FLHS, FLHR, 1986-08 FLSTC, and 1993-96 FLSTN models. Does not fit FLSTS, FLHRS or FLTR.

**63035** 59081-96



## Stainless Steel Fender Trim Set

Includes 2 of 9" and 2 of 10" strips for the top of all 7-1/4" wide rigid, swingarm, or bobbed rear fenders. T-bolts and template provided to ease installation.

**27158**



## Front Fender Side Rails

These fender side rails come as a set with hardware.

**4350** Stainless Steel FL 1967-on (59209-91T)

**29031** Chrome FL touring 1982-on (not Road Glide or Road King Custom, FLST/C/N 1986-on (59209-91T) (requires purchase of "T" bolt kit)

**24036** "T" bolt kit (4 T-bolts, 4 lock washers, 4 nuts)



## Front Fender Rail for Heritage Models

Styled after the front bumper used on Panheads to the mid-60's. This front trim is formed from 3/4" chromed steel tubing. It comes complete and ready to install on the front fender of all Heritage Softail models. Front and rear fender rails set the bike off.

**54502** V-Design



## Rear Fender Rails for Heritage Models

Styled after the rear bumper used on Panheads to the early 60's. This 'made in the USA' rear trim is formed from 3/4" chromed steel tubing. It comes complete and ready to install on the rear fender of Heritage Softail models.

**54501** Heritage Softail 1986-99 (91081-93)

**29654** FLST 2000-on (91402-00)



## Chrome Fender Nameplate for Road King

**29656** 14422-94 (each)



## Chrome Fender Nameplate for Ultra Classic

**29655** 59236-97 (each)



## Glide Fender Nameplate

Chrome nameplate for 1965-on FL-FLH.

**2113** 59196-65 (pair)

# Fender Trim

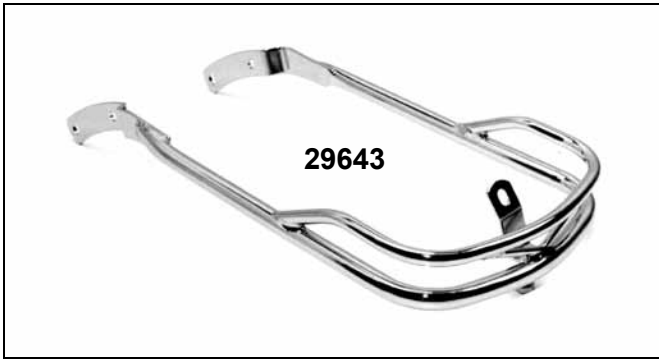

29643



29654

## Heritage Chrome Fender Rail (not FLSTS)

- | PCP   | Application                                       |
|-------|---|
| 29643 | Front 1987-on FLST/C and 1993-96 FLSTN (91080-93) |
| 29654 | Rear 2000-on FLST/C (91402-00)                    |

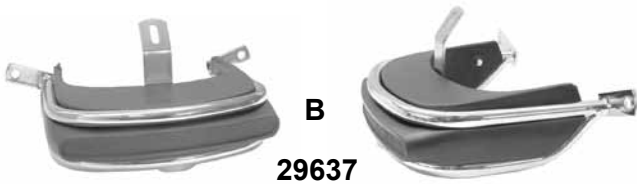

B  
29637

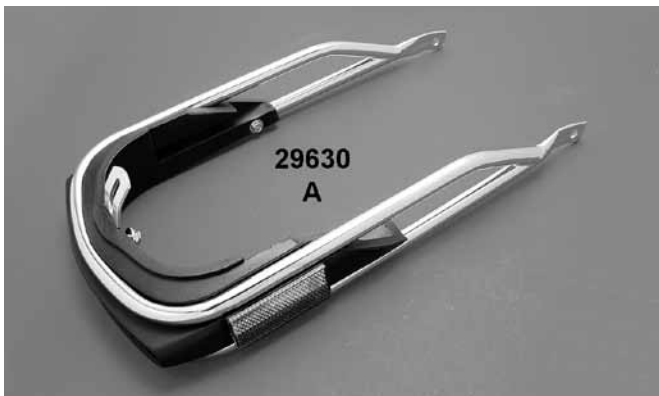

29630  
A

## Front and Rear Bumpers

Bumpers feature rubber inserts as OEM.

- | PCP   | Description   |
|-------|---|
| 29630 | (A) Front FLT 1983-06, FLHT 1996-on, FLHS 1987-93 FLHR 1994-on (not 1998-on FLTR) (91085-83C) |
| 29631 | (A) Front rubber insert 1977-on (91107-77A)   |
| 29637 | (B) Rear 1979-on (91013-79A)  |
| 62016 | Reflector 1968-on (59261-77) (pair)   |
| 12636 | Reflector speed nut (8126A) (10 pack)   |



54502

## Chrome Front Fender Trim Rail

Features V-Design for 1987-ON FLT-FLST-FLHR models. Does not fit FLSTS.

54502 1987-on FLST/C, 1993-96 FLSTN (91080-93)



45401

45400

## Chrome Bumper Trim Rail For FLST 1987-93

45400 Front



## Rear Fender Rail Insert

Fits 1980-08 Tour Glide, FLHS, FLHR, FLHT/C/U and 2006-08 FLHX. Not for Road Glide or Road King Classic.

64261 91357-99



## Front Fender Rail Insert

Fits 1980-on Tour Glides, FLHTC/I, FLHTCU/I. Not for use on 1998-on FLTR/I, FLHRS or 1994-on FLHR/I.

64260 91358-99A

# Luggage Racks

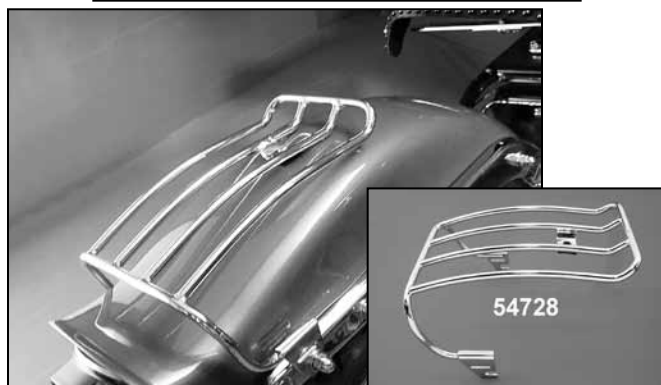
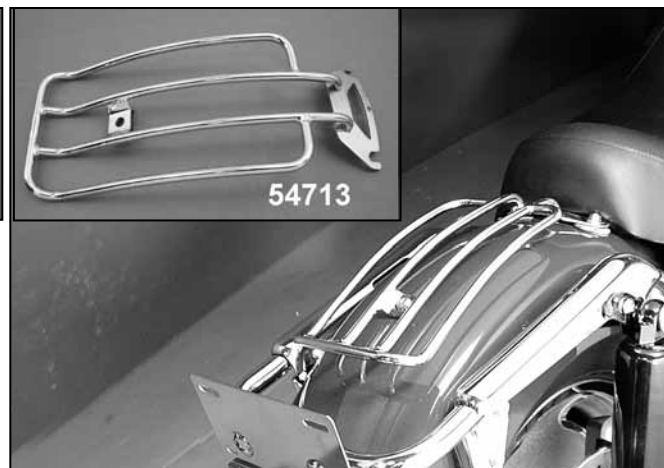
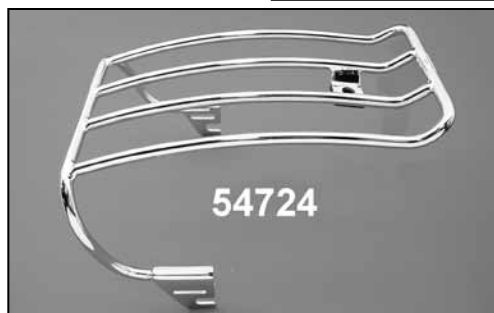
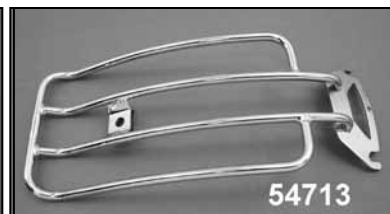

## Luggage Rack Pad

Measures 12-3/4" x 9" with quicker release spring loaded clamps to fit 3-channel stock luggage racks.

- 3017 Pad
- 27205 Mount clamp kit

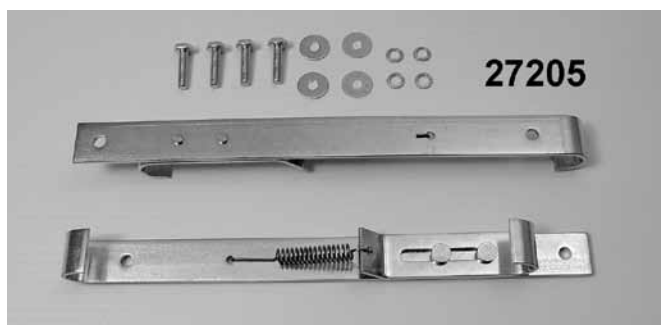

## Contour Fender Racks

Feature solid steel construction for use with solo seats.

- | PCP   | Application                     |
|-------|---------------------------------|
| 54728 | 1984-99 FXST                    |
| 54724 | 2000-04 FXST-FLST               |
| 54726 | 1991-2004 FXD                   |
| 54727 | 1993-2003 FXDWG                 |
| 54731 | 2006-on FXDWG                   |
| 54713 | 1998-2006 FLHR (11"IL x 6-5/8") |

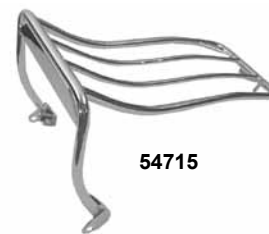
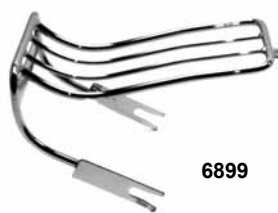

## Chrome Luggage Racks FXWG, FXST

Luggage racks fit FXWG, FXST, FXSTC and FXSTS models as well as any other Big Twin models which have been converted to a Fat Bob rear fender and many swing arm frames fitted with a bobbed rear fender.

- | PCP   | Description                                   |
|-------|---|
| 6899  | 1980-99 Bobtail rack, FXST/B/SB/C (56466-86A) |
| 54715 | 2000-02 Bobtail luggage rack (56454-00)       |
| 54716 | 2003-05 Bobtail rack FXST/B/S (56481-03)      |
| 54730 | 2006-on FXST (60161-06)                       |

# Luggage Racks



54701

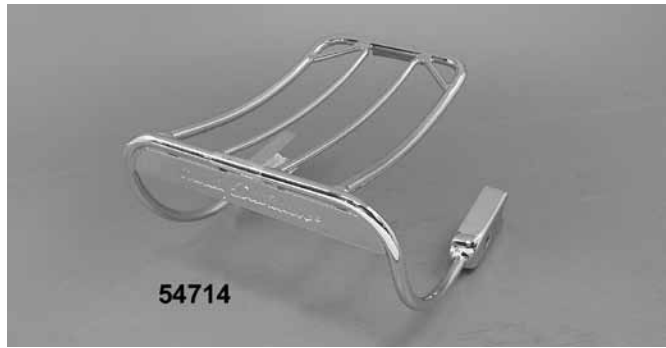

54714

## Chrome Rear Fender Luggage Racks

Available to fit a variety of models, these new luggage racks are easy to install and remove. Triple chrome plated and made out of 3/8 steel tubing. Mounts to stock seat bracket and license plate bracket

- 54701 1982-94 all FXR, 1976-85 FXE ( 9-1/2"L x 6"W)
- 54702 1986-05 all Heritage Softail models and Fatboys (10-1/2"L x 6"W)
- 54711 1993-01 FXDWG (9"L x 6"W)
- 54714 2002-04 FXDWG (56495-02)
- 54709 1993-05 FXD (9"L x 6"W)



54709

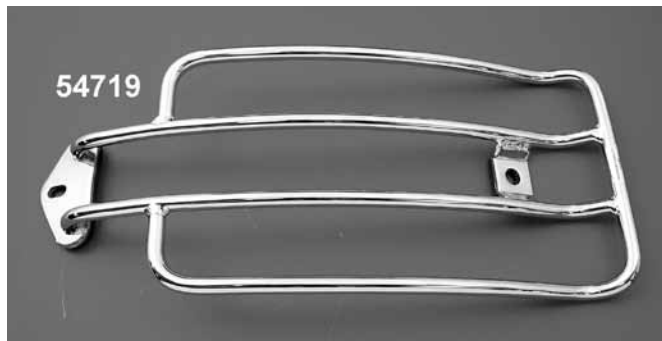

54719

**Note: The cargo capacity of these racks is limited to ten pounds or less.**



54700



54720



54721

## Sportster Chrome Luggage Racks

Measure 6" x 8" for fender mounting on XL's. For loads of 10 pounds or less.

PCP	Application	Seat
54700	1979-03	Stock
54720	2004-06	Stock
54710	1994-03	Solo
54719	1985-03	Solo
54721	2004-06	Solo

# Luggage Racks

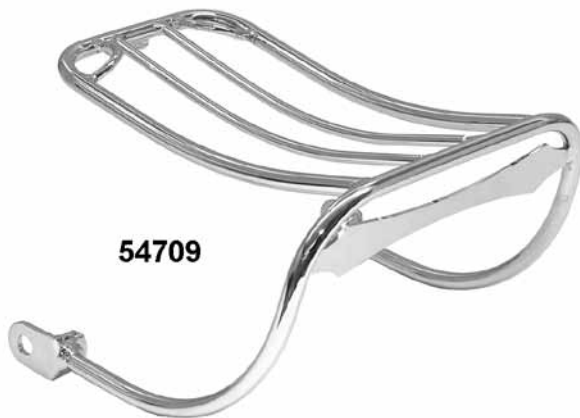

54709

## Dyna Glide Luggage Rack 1993-05

This chrome rack fits all Dyna models. Follows contour of fender and mounts to the rear strut and the seat mounting hole. Suitable for LIGHT LOADS of approximately 10 pounds.  
54709



## T/L Full Size Tour-Pak Luggage Rack

Chrome rack is well suited for King and Chopper Tour-Pak lids with arm rest style passenger backrests. Rack reduces scratching to both the lid and the backrest. Includes mounting hardware.

66021 53665-87



## T/L Chrome Mini Tour-Pak Lid Rack

Chromed steel rack fits King and Chopped Tour-Paks except 2003 FLHTC/UI, 2000-01 FLTRSEI.

66019 53100-96



## T/L Chrome Nostalgic Tour-Pak Lid Rack

Chrome rack style matches Nostalgic saddlebag lid and guard rails. Fits all King and Chopped Tour-Paks. Mount holes are 12-7/8" wide by 7-1/2" deep.

66020 53101-96



## T/L Chrome FLHR Luggage Rack

Fits FLHR, FLHT and FLTR 1997-08.

54722 53341-97A

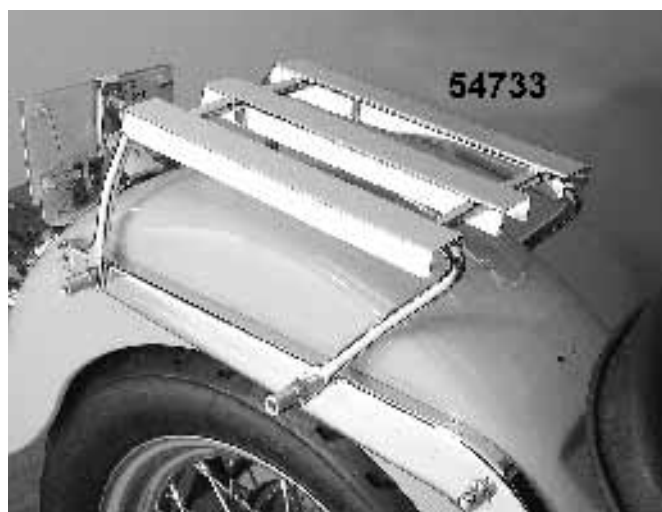

## Retro Luggage Rack

Fits 1998-on FLHR with solo seat.

PCP	Year
54733	1998-on
54734	1989-97

# Luggage Racks



**T/L Luggage Carrier FLT 1992-96**  
**66009** 53411-92A



**T/L Chrome Rear Luggage Rack**  
 Fits 1986-02 FXST models.  
**54718**

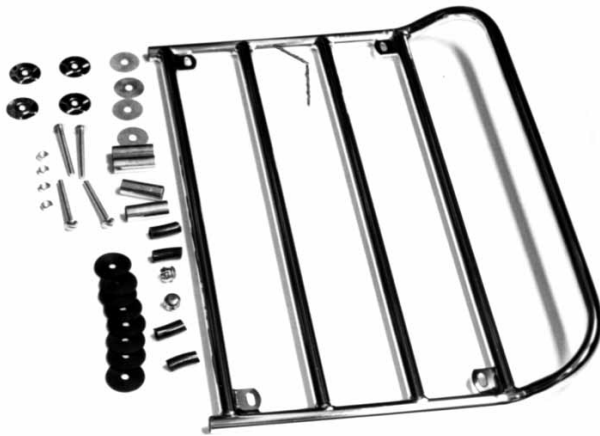

**Luggage Rack for Harley Tour Pak**  
 Designed especially for the Harley King Tour Pak. A higher back lip is incorporated into the design to safely hold your cargo. Complete with all hardware necessary for an easy installation.  
**7003** Measures 13-1/2" x 19".

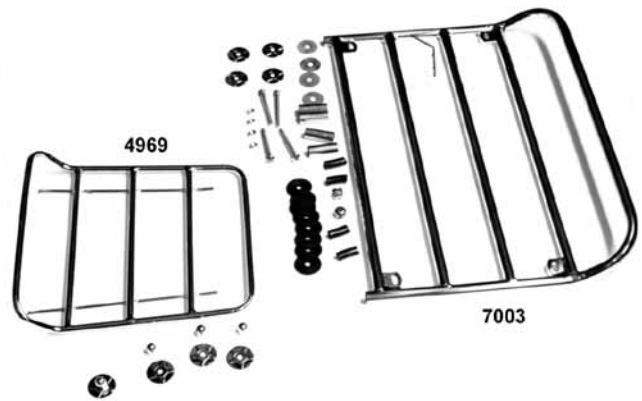

**Mini Luggage Rack**  
 Mounts on H-D King Tour Pak. Fits nicely inside indent. Also fits other tour packs with 10 inch flat square surface. Pack measures 11-1/4" long x 9-1/4" at front and 10-1/2" at rear.  
**4969**

**Old Style Luggage Rack**  
 Replica of 1940's accessory. Contours to all fenders 1934-on. Great for attaching throw-over saddlebags. Does not interfere with post mounted buddy or police solo seats.  
**PCP Finish**  
**54717** Polished  
**3215** Chrome



**Chrome Three Rail Luggage Rack**  
 1960's Style retro style racks fit FXST-FLST but not FLSTS.  
**Note:** FLSTF models require turn signal relocation.  
**PCP Description**  
**54704** 1986-06 (11-3/4"L x 8-1/2" W) (53461-90)  
**54708** 2000-06  
**54732** 2007-on